



www.osteofrance-ortho.fr

catalogue de produits

Arthroplastie | Traumatisme | Arthroscopie | Colonne vertébrale



07

Systèmes de plaques



| | |
|---|----|
| Système de plaque de verrouillage à gros fragments | 4 |
| Système de plaque de verrouillage pour petits fragments | 12 |
| Systèmes de mini-plaques verrouillables | 29 |
| Plaques de verrouillage DHS-DCS | 31 |

37

Systèmes d'arthroplastie



| | |
|---|----|
| Prothèse de l'articulation de la hanche | 34 |
| Révision de prothèse articulaire de la hanche | 37 |
| Prothèse totale de l'articulation du genou | 39 |
| Genou Vision-R | 42 |

43

Systèmes de clous



| | |
|---|----|
| Systèmes d'ongles PFNA | 47 |
| Systèmes de clous fémoraux multi-usages ZFN | 49 |
| Systèmes de clous pour arthrodèse fémur-tibia | 50 |
| Clou fémoral rétrograde | 51 |
| Systèmes de clous tibiaux ZTN | 52 |
| Clou huméral intramédullaire canulé | 53 |
| Clou élastique en titane | 54 |

53

Systèmes de fixation externes



| | |
|--|----|
| Fixateurs externes | 57 |
| Fixateurs externes hybrides | 60 |
| Petit ensemble de fixateurs tubulaires externes | 61 |
| Ensemble de grands fixateurs tubulaires externes | 62 |

Broches et fils squelettiques 63

Systèmes spinaux 64

Arthroscopie 65

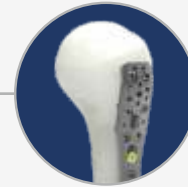

Systèmes de plaques

| | |
|---|----|
| Système de plaque de verrouillage à gros fragments | 4 |
| Système de plaque de verrouillage pour petits fragments | 12 |
| Plaques de verrouillage DHS-DCS | 29 |
| Systèmes de mini-plaques verrouillables | 31 |



Systèmes d'arthroplastie



Systèmes de clous



Systèmes de fixation externes

Broches et fils squelettiques

Systèmes spinaux

Arthroscopie

THE SYSTEMS



Systemes de plaques

Systeme de plaque de verrouillage à gros fragments

Plaque tibiale médiale proximale verrouillable

avec vis $\varnothing 5,0$ - $\varnothing 4,5$ mm

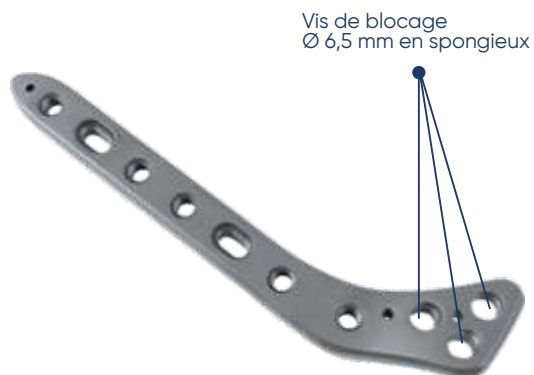

| RÉF. NON | TROUS |
|-----------|-------|
| 1572-1008 | 8-D |
| 1572-1010 | 10-D |
| 1572-1012 | 12-D |
| 1572-1014 | 14-D |
| 1572-1016 | 16-D |
| 1572-2008 | 8-G |
| 1572-2010 | 10-G |
| 1572-2012 | 12-G |
| 1572-2014 | 14-G |
| 1572-2016 | 16-G |

| RÉF. NON | TROUS |
|-----------|-------|
| 1822-1008 | 8-D |
| 1822-1010 | 10-D |
| 1822-1012 | 12-D |
| 1822-1014 | 14-D |
| 1822-1016 | 16-D |
| 1822-2008 | 8-G |
| 1822-2010 | 10-G |
| 1822-2012 | 12-G |
| 1822-2014 | 14-G |
| 1822-2016 | 16-G |

Plaque de verrouillage en L pour tibia latéral proximal

avec vis $\varnothing 5,0$ - $\varnothing 4,5$ mm

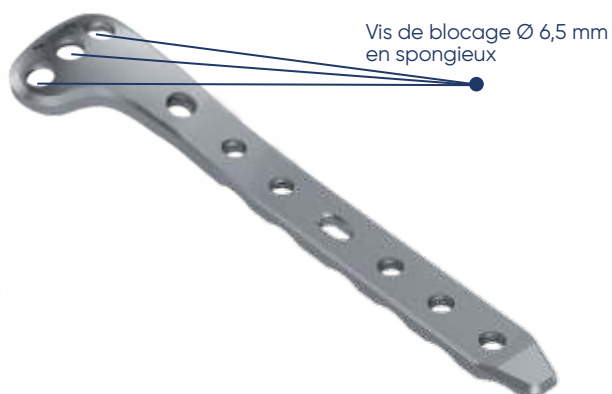

Plaque de verrouillage en T pour tibia médial proximal

avec vis $\varnothing 5,0$ - $\varnothing 4,5$ mm

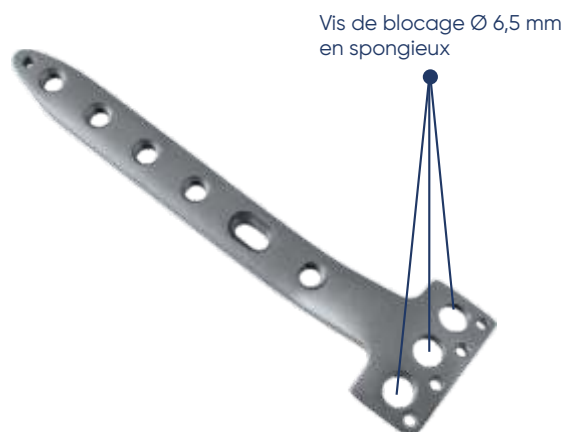

| RÉF. NON | TROUS |
|-----------|-------|
| 1792-1007 | 7-D |
| 1792-1009 | 9-D |
| 1792-1011 | 11-D |
| 1792-2007 | 7-G |
| 1792-2009 | 9-G |
| 1792-2011 | 11-G |

Systemes de plaques

Systeme de plaque de verrouillage a gros fragments



| RÉF. NON | TROUS |
|-------------|--------|
| 10132-10010 | 10 - D |
| 10132-10012 | 12- D |
| 10132-10014 | 14 - D |
| 10132-10016 | 16 - D |
| 10132-10018 | 18- D |
| 10132-20010 | 10 - G |
| 10132-20012 | 12 - G |
| 10132-20014 | 14 - G |
| 10132-20016 | 16 - G |
| 10132-20018 | 18 - G |

Ø 4,0 mm Cancellous Locking Screw

Plaque tibiale antérolatérale distale verrouillable
avec vis Ø 3,5 mm



Plaque de verrouillage pour point tibial médial distal
(combinaison 3,5-5,0)
avec vis Ø 3,5 - Ø 5,0 mm

Vis de blocage Ø 3,5 mm

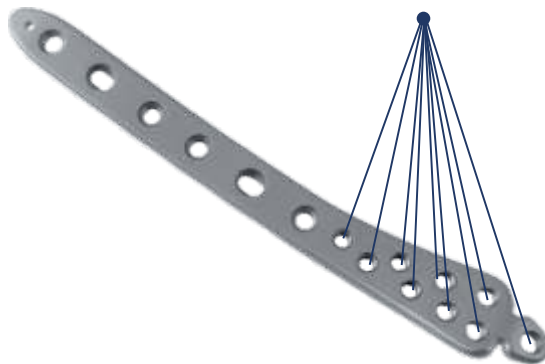

| RÉF. NON | TROUS |
|-----------|-------|
| 1032-1013 | 13-D |
| 1032-1015 | 15-D |
| 1032-1017 | 17-D |
| 1032-1019 | 19-D |
| 1032-1021 | 21-D |
| 1032-2013 | 13-G |
| 1032-2015 | 15-G |
| 1032-2017 | 17-G |
| 1032-2019 | 19-G |
| 1032-2021 | 21-G |

| RÉF. NON | TROUS |
|-----------|-------|
| 1582-1008 | 8-D |
| 1582-1010 | 10-D |
| 1582-1012 | 12-D |
| 1582-1014 | 14-D |
| 1582-1016 | 16-D |
| 1582-2008 | 8-G |
| 1582-2010 | 10-G |
| 1582-2012 | 12-G |
| 1582-2014 | 14-G |
| 1582-2016 | 16-G |

Plaque tibiale latérale distale verrouillable
avec vis Ø 5,0 - Ø 4,5 mm

Vis de blocage Ø 6,5 mm
en spongieux

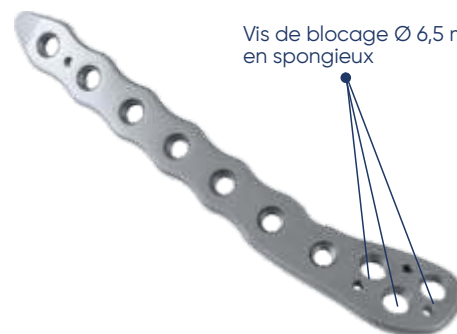



Systemes de plaques

Systeme de plaque de verrouillage à gros fragments

Plaque large verrouillable LC DCP (5,0 mm)

avec vis \varnothing 5,0 - \varnothing 4,5 mm



| RÉF. NON | TROUS |
|-----------|-------|
| 1372-0004 | 4 |
| 1372-0005 | 5 |
| 1372-0006 | 6 |
| 1372-0007 | 7 |
| 1372-0008 | 8 |
| 1372-0009 | 9 |
| 1372-0010 | 10 |
| 1372-0011 | 11 |
| 1372-0012 | 12 |
| 1372-0013 | 13 |
| 1372-0014 | 14 |
| 1372-0015 | 15 |
| 1372-0016 | 16 |

| RÉF. NON | TROUS |
|-----------|-------|
| 1382-0004 | 4 |
| 1382-0005 | 5 |
| 1382-0006 | 6 |
| 1382-0007 | 7 |
| 1382-0008 | 8 |
| 1382-0009 | 9 |
| 1382-0010 | 10 |
| 1382-0011 | 11 |
| 1382-0012 | 12 |
| 1382-0013 | 13 |
| 1382-0014 | 14 |
| 1382-0015 | 15 |
| 1382-0016 | 16 |

Plaque étroite verrouillable LC DCP (5,0 mm)

avec vis \varnothing 5,0 - \varnothing 4,5 mm



Câble de verrouillage LC DCP à plaque large

avec vis \varnothing 5,0 - \varnothing 4,5 mm



| RÉF. NON | TROUS |
|-----------|-------|
| 1982-0004 | 4 |
| 1982-0005 | 5 |
| 1982-0006 | 6 |
| 1982-0007 | 7 |
| 1982-0008 | 8 |

Systemes de plaques

Systeme de plaque de verrouillage à gros fragments



Plaque fémorale distale latérale verrouillable
avec vis Ø 5,0 - Ø 4,5 mm

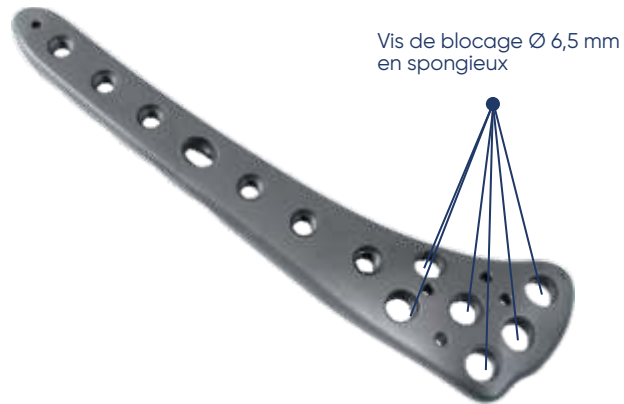

| RÉF. NON | TROUS |
|-----------|-------|
| 1542-1013 | 13-D |
| 1542-1015 | 15-D |
| 1542-1017 | 17-D |
| 1542-1019 | 19-D |
| 1542-1021 | 21-D |
| 1542-2013 | 13-G |
| 1542-2015 | 15-G |
| 1542-2017 | 17-G |
| 1542-2019 | 19-G |
| 1542-2021 | 21-G |

| RÉF. NON | TROUS |
|-----------|-------|
| 1552-1009 | 9-D |
| 1552-1011 | 11-D |
| 1552-1013 | 13-D |
| 1552-1015 | 15-D |
| 1552-1017 | 17-D |
| 1552-2009 | 9-G |
| 1552-2011 | 11-G |
| 1552-2013 | 13-G |
| 1552-2015 | 15-G |
| 1552-2017 | 17-G |

Plaque fémorale latérale proximale verrouillable
avec vis Ø 5,0 - Ø 4,5 mm

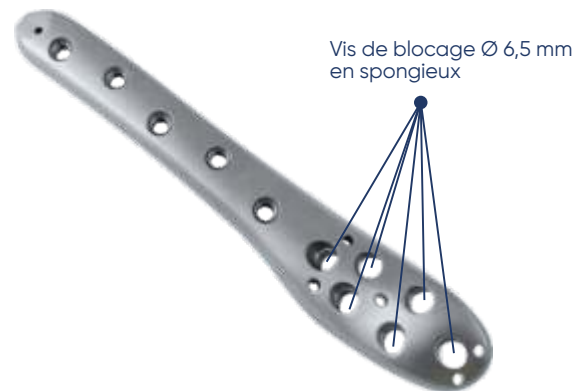

Plaque de fixation verrouillable
avec vis Ø 5,0 - Ø 4,5 mm

Vis de blocage Ø 5,0 mm

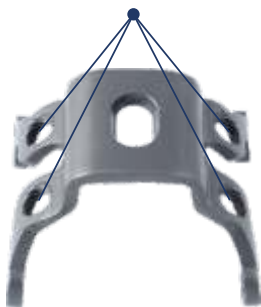

| RÉF. NON | TROUS |
|-------------|-------|
| 10022-00008 | 8 |

Plaque de fixation verrouillable
Vis de connexion 5,0 mm



RÉF. NON
2912-5000





Systemes de plaques

Systeme de plaque de verrouillage à gros fragments

Plaque fémorale distale latérale verrouillable mini-invasive

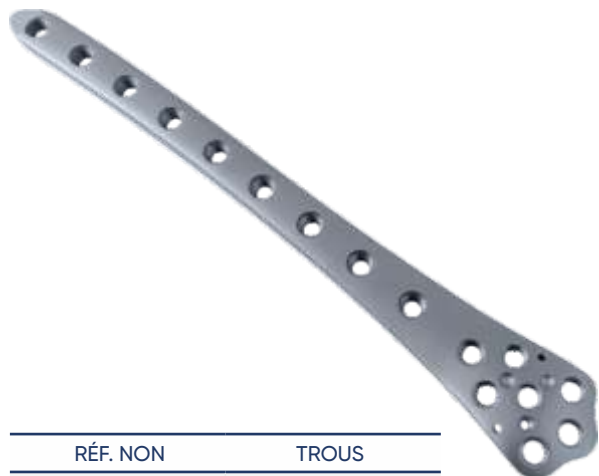

| RÉF. NON | TROUS |
|-----------|-------|
| 1802-1012 | 12-D |
| 1802-1016 | 16-D |
| 1802-1020 | 20-D |
| 1802-2012 | 12-G |
| 1802-2016 | 16-G |
| 1802-2020 | 20-G |

Plaque tibiale latérale proximale verrouillable mini-invasive



| RÉF. NON | TROUS |
|-----------|-------|
| 1782-1010 | 10-D |
| 1782-1014 | 14-D |
| 1782-1018 | 18-D |
| 1782-2010 | 10-G |
| 1782-2014 | 14-G |
| 1782-2018 | 18-G |

Vis de blocage autoperceuses 5,0 mm

Auto-perçage



| RÉF. NON | LONGUEUR (mm) |
|-----------|---------------|
| 2192-5018 | 18 |
| 2192-5020 | 20 |
| 2192-5025 | 25 |
| 2192-5030 | 30 |
| 2192-5035 | 35 |
| 2192-5040 | 40 |
| 2192-5045 | 45 |
| 2192-5050 | 50 |
| 2192-5055 | 55 |
| 2192-5060 | 60 |
| 2192-5065 | 65 |
| 2192-5070 | 70 |
| 2192-5075 | 75 |
| 2192-5080 | 80 |
| 2192-5085 | 85 |
| 2192-5090 | 90 |
| 2192-5095 | 95 |
| 2192-5100 | 100 |
| 2192-5105 | 105 |
| 2192-5110 | 110 |
| 2192-5115 | 115 |



Systemes de plaques

Systeme de plaque de verrouillage à gros fragments



Plaque de verrouillage pour tête fémorale latérale proximale

Vis canulée verrouillable Ø 7,3 mm

Vis corticale Ø 4,5 mm

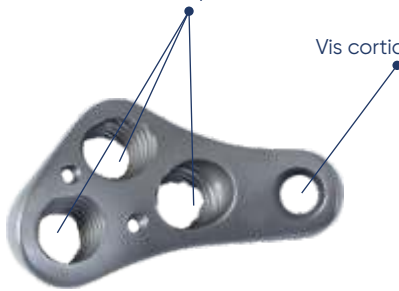

| RÉF. NON | TROUS |
|-----------|-------|
| 1042-1004 | 4-D |
| 1042-2004 | 4-G |



Vis canulée verrouillable
(Ø 7,3 mm) (Fileté 16 mm)



| RÉF. NON | LONGUEUR (mm) |
|-----------|---------------|
| 2412-7050 | 50 |
| 2412-7055 | 55 |
| 2412-7060 | 60 |
| 2412-7065 | 65 |
| 2412-7070 | 70 |
| 2412-7075 | 75 |
| 2412-7080 | 80 |
| 2412-7085 | 85 |
| 2412-7090 | 90 |
| 2412-7095 | 95 |
| 2412-7100 | 100 |
| 2412-7105 | 105 |
| 2412-7110 | 110 |
| 2412-7115 | 115 |
| 2412-7120 | 120 |



Vis canulée verrouillable
(Ø 7,3 mm) (Fileté 32 mm)



| REF. NO | LONGUEUR (mm) |
|-----------|---------------|
| 2902-7050 | 50 |
| 2902-7055 | 55 |
| 2902-7060 | 60 |
| 2902-7065 | 65 |
| 2902-7070 | 70 |
| 2902-7075 | 75 |
| 2902-7080 | 80 |
| 2902-7085 | 85 |
| 2902-7090 | 90 |
| 2902-7095 | 95 |
| 2902-7100 | 100 |
| 2902-7105 | 105 |
| 2902-7110 | 110 |
| 2902-7115 | 115 |
| 2902-7120 | 120 |





Vis

Système de plaque de verrouillage à gros fragments

Vis de verrouillage (Ø 5.0 mm)



| RÉF. NON | LONGUEUR (mm) |
|-----------|------------------|
| 2052-5012 | 12 |
| 2052-5014 | 14 |
| 2052-5016 | 16 |
| 2052-5018 | 18 |
| 2052-5020 | 20 |
| 2052-5022 | 22 |
| 2052-5024 | 24 |
| 2052-5026 | 26 |
| 2052-5028 | 28 |
| 2052-5030 | 30 |
| 2052-5032 | 32 |
| 2052-5034 | 34 |
| 2052-5036 | 36 |
| 2052-5038 | 38 |
| 2052-5040 | 40 |
| 2052-5042 | 42 |
| 2052-5044 | 44 |
| 2052-5046 | 46 |
| 2052-5048 | 48 |
| 2052-5050 | 50 |
| 2052-5055 | 55 |
| 2052-5060 | 60 |
| 2052-5065 | 65 |
| 2052-5070 | 70 |
| 2052-5075 | 75 |
| 2052-5080 | 80 |
| 2052-5085 | 85 |
| 2052-5090 | 90 |
| 2052-5095 | 95 |

Vis canulée verrouillable (Ø 5.0 mm)



| RÉF. NON | LONGUEUR (mm) |
|-----------|------------------|
| 2412-5012 | 12 |
| 2412-5014 | 14 |
| 2412-5016 | 16 |
| 2412-5018 | 18 |
| 2412-5020 | 20 |
| 2412-5022 | 22 |
| 2412-5024 | 24 |
| 2412-5026 | 26 |
| 2412-5028 | 28 |
| 2412-5030 | 30 |
| 2412-5032 | 32 |
| 2412-5034 | 34 |
| 2412-5036 | 36 |
| 2412-5038 | 38 |
| 2412-5040 | 40 |
| 2412-5042 | 42 |
| 2412-5044 | 44 |
| 2412-5046 | 46 |
| 2412-5048 | 48 |
| 2412-5050 | 50 |
| 2412-5055 | 55 |
| 2412-5060 | 60 |
| 2412-5065 | 65 |
| 2412-5070 | 70 |
| 2412-5075 | 75 |
| 2412-5080 | 80 |
| 2412-5085 | 85 |
| 2412-5090 | 90 |
| 2412-5095 | 95 |

Vis spongieuse de blocage (Ø 6.5 mm)



| RÉF. NON | LONGUEUR (mm) |
|-----------|------------------|
| 2182-0030 | 30 |
| 2182-0035 | 35 |
| 2182-0040 | 40 |
| 2182-0045 | 45 |
| 2182-0050 | 50 |
| 2182-0055 | 55 |
| 2182-0060 | 60 |
| 2182-0065 | 65 |
| 2182-0070 | 70 |
| 2182-0075 | 75 |
| 2182-0080 | 80 |
| 2182-0085 | 85 |
| 2182-0090 | 90 |
| 2182-0095 | 95 |
| 2182-0100 | 100 |
| 2182-0105 | 105 |
| 2182-0110 | 110 |
| 2182-0115 | 115 |
| 2182-0120 | 120 |

Vis de verrouillage de l'adaptateur de câble



| RÉF. NON | LONGUEUR (mm) |
|-----------|------------------|
| 2602-5000 | 5.0 |
| 2602-3500 | 3.5 |

Bouchon à vis de verrouillage



| RÉF. NON | LONGUEUR (mm) |
|-----------|------------------|
| 2052-5000 | 5.0 |

Vis

Système de plaque de verrouillage à gros fragments

Vis spongieuse

(Ø 6.5 mm) (16 mm fileté)



| RÉF. NON | LONGUEUR (mm) |
|-----------|---------------|
| 2402-0030 | 30 |
| 2402-0035 | 35 |
| 2402-0040 | 40 |
| 2402-0045 | 45 |
| 2402-0050 | 50 |
| 2402-0055 | 55 |
| 2402-0060 | 60 |
| 2402-0065 | 65 |
| 2402-0070 | 70 |
| 2402-0075 | 75 |
| 2402-0080 | 80 |
| 2402-0085 | 85 |
| 2402-0090 | 90 |
| 2402-0095 | 95 |
| 2402-0100 | 100 |
| 2402-0105 | 105 |
| 2402-0110 | 110 |
| 2402-0115 | 115 |
| 2402-0120 | 120 |

Vis spongieuse

(Ø 6.5 mm) (32 mm fileté)



| RÉF. NON | LONGUEUR (mm) |
|-----------|---------------|
| 2952-0040 | 40 |
| 2952-0045 | 45 |
| 2952-0050 | 50 |
| 2952-0055 | 55 |
| 2952-0060 | 60 |
| 2952-0065 | 65 |
| 2952-0070 | 70 |
| 2952-0075 | 75 |
| 2952-0080 | 80 |
| 2952-0085 | 85 |
| 2952-0090 | 90 |
| 2952-0095 | 95 |
| 2952-0100 | 100 |
| 2952-0105 | 105 |
| 2952-0110 | 110 |
| 2952-0115 | 115 |
| 2952-0120 | 120 |

Cortical Screw

(Ø 4.5 mm)



| RÉF. NON | LONGUEUR (mm) |
|-----------|---------------|
| 2012-4512 | 12 |
| 2012-4514 | 14 |
| 2012-4516 | 16 |
| 2012-4518 | 18 |
| 2012-4520 | 20 |
| 2012-4522 | 22 |
| 2012-4524 | 24 |
| 2012-4526 | 26 |
| 2012-4528 | 28 |
| 2012-4530 | 30 |
| 2012-4532 | 32 |
| 2012-4534 | 34 |
| 2012-4536 | 36 |
| 2012-4538 | 38 |
| 2012-4540 | 40 |
| 2012-4542 | 42 |
| 2012-4544 | 44 |
| 2012-4546 | 46 |
| 2012-4548 | 48 |
| 2012-4550 | 50 |
| 2012-4552 | 52 |
| 2012-4554 | 54 |
| 2012-4556 | 56 |
| 2012-4558 | 58 |
| 2012-4560 | 60 |
| 2012-4565 | 65 |
| 2012-4570 | 70 |
| 2012-4575 | 75 |
| 2012-4580 | 80 |
| 2012-4585 | 85 |
| 2012-4590 | 90 |



Systemes de plaques

Systeme de plaque de verrouillage pour petits fragments

Plaque humerale distale laterale verrouillable

avec vis \varnothing 3,5 - \varnothing 4,0 mm



| RÉF. NON | TROUS |
|-----------|-------|
| 1682-1008 | 8-D |
| 1682-1010 | 10-D |
| 1682-1012 | 12-D |
| 1682-1014 | 14-D |
| 1682-2008 | 8-G |
| 1682-2010 | 10-G |
| 1682-2012 | 12-G |
| 1682-2014 | 14-G |

| RÉF. NON | TROUS |
|-----------|-------|
| 1532-1008 | 8-D |
| 1532-1010 | 10-D |
| 1532-1012 | 12-D |
| 1532-1014 | 14-D |
| 1532-1016 | 16-D |
| 1532-2008 | 8-G |
| 1532-2010 | 10-G |
| 1532-2012 | 12-G |
| 1532-2014 | 14-G |
| 1532-2016 | 16-G |

Plaque humerale mediale distale verrouillable

avec vis \varnothing 3,5 - \varnothing 4,0 mm



Plaque en Y humerale distale verrouillable

avec vis \varnothing 3,5 - \varnothing 4,0 mm



| RÉF. NON | TROUS |
|-----------|-------|
| 1512-1009 | 9-D |
| 1512-1010 | 10-D |
| 1512-1011 | 11-D |
| 1512-1012 | 12-D |
| 1512-2009 | 9-G |
| 1512-2010 | 10-G |
| 1512-2011 | 11-G |
| 1512-2012 | 12-G |

Plaque humerale posterieure distale verrouillable

avec vis \varnothing 3,5 - \varnothing 4,0 mm



| RÉF. NON | TROUS |
|-----------|-------|
| 1502-1008 | 8-D |
| 1502-1010 | 10-D |
| 1502-1012 | 12-D |
| 1502-2008 | 8-G |
| 1502-2010 | 10-G |
| 1502-2012 | 12-G |

Systemes de plaques

Systeme de plaque de verrouillage pour petits fragments



| RÉF. NON | TROUS |
|-----------|-------|
| 1662-1008 | 8-D |
| 1662-1010 | 10-D |
| 1662-1012 | 12-D |
| 1662-1014 | 14-D |
| 1662-1016 | 16-D |
| 1662-2008 | 8-G |
| 1662-2010 | 10-G |
| 1662-2012 | 12-G |
| 1662-2014 | 14-G |
| 1662-2016 | 16-G |



Plaque olécranienne verrouillable

avec vis \varnothing 3,5 - \varnothing 4,0 mm

Plaque de verrouillage pour humérus latéral proximal (LARGE)

avec vis \varnothing 3,5 - \varnothing 4,0 mm

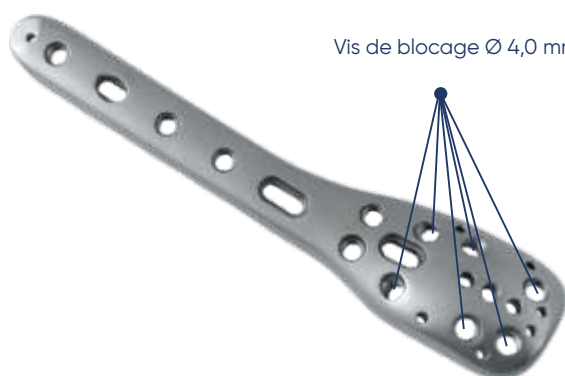

Vis de blocage \varnothing 4,0 mm Spongieux

| RÉF. NON | TROUS |
|-----------|-------|
| 1832-1012 | 12-D |
| 1832-1014 | 14-D |
| 1832-1016 | 16-D |
| 1832-1018 | 18-D |
| 1832-1020 | 20-D |
| 1832-2012 | 12-G |
| 1832-2014 | 14-G |
| 1832-2016 | 16-G |
| 1832-2018 | 18-G |
| 1832-2020 | 20-G |

| RÉF. NON | TROUS |
|-----------|-------|
| 1912-1012 | 12-D |
| 1912-1014 | 14-D |
| 1912-1016 | 16-D |
| 1912-1018 | 18-D |
| 1912-1020 | 20-D |
| 1912-2012 | 12-G |
| 1912-2014 | 14-G |
| 1912-2016 | 16-G |
| 1912-2018 | 18-G |
| 1912-2020 | 20-G |

Plaque humérale proximale latérale verrouillable mini-invasive (SMALL)

avec vis \varnothing 3,5 mm

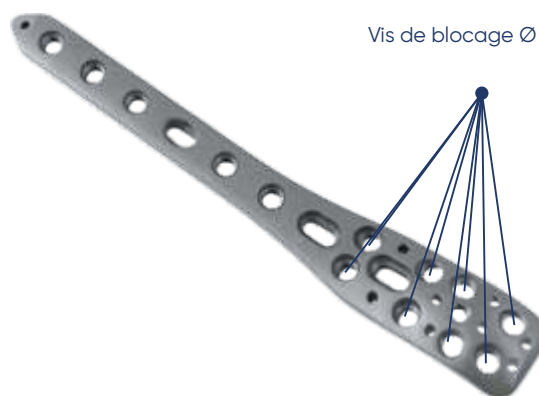

Vis de blocage \varnothing 4,0 mm Spongieux





Systemes de plaques

Systeme de plaque de verrouillage pour petits fragments

Plaque large verrouillable LC DCP 3,5 mm
avec vis \varnothing 3,5 - \varnothing 4,0 mm



| RÉF. NON | TROUS |
|-----------|-------|
| 1402-0004 | 4 |
| 1402-0005 | 5 |
| 1402-0006 | 6 |
| 1402-0007 | 7 |
| 1402-0008 | 8 |
| 1402-0009 | 9 |
| 1402-0010 | 10 |
| 1402-0011 | 11 |
| 1402-0012 | 12 |
| 1402-0013 | 13 |
| 1402-0014 | 14 |

| RÉF. NON | TROUS |
|-----------|-------|
| 1392-0004 | 4 |
| 1392-0005 | 5 |
| 1392-0006 | 6 |
| 1392-0007 | 7 |
| 1392-0008 | 8 |
| 1392-0009 | 9 |
| 1392-0010 | 10 |
| 1392-0011 | 11 |
| 1392-0012 | 12 |
| 1392-0013 | 13 |
| 1392-0014 | 14 |

Plaque étroite verrouillable LC Dcp 3,5 mm
avec vis \varnothing 3,5 - \varnothing 4,0 mm



Plaque tubulaire verrouillable au tiers
avec vis \varnothing 3,5 - \varnothing 4,0 mm



| RÉF. NON | TROUS |
|-----------|-------|
| 1432-0004 | 4 |
| 1432-0005 | 5 |
| 1432-0006 | 6 |
| 1432-0007 | 7 |
| 1432-0008 | 8 |
| 1432-0009 | 9 |
| 1432-0010 | 10 |
| 1432-0011 | 11 |
| 1432-0012 | 12 |
| 1432-0013 | 13 |
| 1432-0014 | 14 |

Systemes de plaques

Systeme de plaque de verrouillage pour petits fragments



Plaque de verrouillage pour radius distal - Volar

avec vis Ø 2,4 - Ø 3,5 mm



Vis de blocage Ø 2,4 mm

| RÉF. NON | TROUS |
|-----------|-------|
| 1442-1012 | 12-D |
| 1442-1013 | 13-D |
| 1442-1014 | 14-D |
| 1442-1015 | 15-D |
| 1442-1016 | 16-D |
| 1442-1017 | 17-D |
| 1442-2012 | 12-G |
| 1442-2013 | 13-G |
| 1442-2014 | 14-G |
| 1442-2015 | 15-G |
| 1442-2016 | 16-G |
| 1442-2017 | 17-G |

Plaque de verrouillage pour radius distal - Volaire / LARGE

avec vis Ø 2,4 - Ø 3,5 mm



Vis de blocage Ø 2,4 mm

| RÉF. NON | TROUS |
|-----------|-------|
| 9922-1012 | 12-D |
| 9922-1013 | 13-D |
| 9922-1014 | 14-D |
| 9922-1015 | 15-D |
| 9922-1016 | 16-D |
| 9922-1017 | 17-D |
| 9922-2012 | 12-G |
| 9922-2013 | 13-G |
| 9922-2014 | 14-G |
| 9922-2015 | 15-G |
| 9922-2016 | 16-G |
| 9922-2017 | 17-G |

Plaque palmaire du radius distal

avec vis Ø 2,4 - Ø 3,5 mm



Vis de blocage Ø 2,4 mm

| RÉF. NON | TROUS |
|------------|-------|
| 10022-1017 | 17-D |
| 10022-2017 | 17-G |

Plaque d'extension palmaire du radius distal

avec vis Ø 2,4 - Ø 3,5 mm



| RÉF. NON | TROUS |
|------------|-------|
| 10032-1006 | 6-D |
| 10032-1009 | 9-D |
| 10032-1012 | 12-D |
| 10032-2006 | 6-G |
| 10032-2009 | 9-G |
| 10032-2012 | 12-G |

Extension de la plaque palmaire

Vis de connexion



| RÉF. NON |
|-----------|
| 2972-0000 |

| RÉF. NON | TROUS |
|-----------|--------|
| 1992-1010 | 10 - D |
| 1992-1011 | 11 - D |
| 1992-1012 | 12 - D |
| 1992-1013 | 13 - D |
| 1992-1014 | 14 - D |
| 1992-1015 | 15 - D |
| 1992-2010 | 10 - G |
| 1992-2011 | 11 - G |
| 1992-2012 | 12 - G |
| 1992-2013 | 13 - G |
| 1992-2014 | 14 - G |
| 1992-2015 | 15 - G |

Plaque de verrouillage pour radius distal - Dorsale

avec vis Ø 2,4 - Ø 3,5 mm



Vis de blocage Ø 2,4 mm



Systemes de plaques

Systeme de plaque de verrouillage pour petits fragments

Plaque de verrouillage pour ulna distal

with \varnothing 3,5 - \varnothing 4.0 mm screw



| RÉF. NON | TROUS |
|-----------|-------|
| 8732-1007 | 7-D |
| 8732-1008 | 8-D |
| 8732-1009 | 9-D |
| 8732-2007 | 7-G |
| 8732-2008 | 8-G |
| 8732-2009 | 9-G |

| RÉF. NON | TROUS |
|-----------|-------|
| 8762-0006 | 6 |
| 8762-0007 | 7 |
| 8762-0008 | 8 |

Plaque de verrouillage pour tête radiale proximale

avec vis \varnothing 3,5 - \varnothing 4,0 mm



Plaque de verrouillage pour point tibial médial distal 3,5 mm

avec vis \varnothing 3,5 - \varnothing 4,0 mm



| RÉF. NON | TROUS |
|-----------|-------|
| 1412-1013 | 13-D |
| 1412-1015 | 15-D |
| 1412-1017 | 17-D |
| 1412-1019 | 19-D |
| 1412-1021 | 21-D |
| 1412-2013 | 13-G |
| 1412-2015 | 15-G |
| 1412-2017 | 17-G |
| 1412-2019 | 19-G |
| 1412-2021 | 21-G |

| REF. NO | HOLES |
|-----------|-------|
| 1752-1009 | 9-D |
| 1752-1011 | 11-D |
| 1752-1013 | 13-D |
| 1752-1015 | 15-D |
| 1752-1017 | 17-D |
| 1752-2009 | 9-G |
| 1752-2011 | 11-G |
| 1752-2013 | 13-G |
| 1752-2015 | 15-G |
| 1752-2017 | 17-G |

Plaque fémorale latérale proximale verrouillable 3,5 mm

avec vis \varnothing 3,5 - \varnothing 4,0 mm



Systèmes de plaques

Système de plaque de verrouillage pour petits fragments



Plaque pour carpe de la main (arthrodèse)
avec vis Ø 3,5 - Ø 4,0 mm



| RÉF. NON | TROUS |
|-----------|-------|
| 1022-0008 | 8 |

Huit assiettes
avec vis Ø 3,5 - Ø 4,0 mm



| RÉF. NON | LONGUEUR (mm) |
|-----------|---------------|
| 1872-0012 | 12 |
| 1872-0016 | 16 |
| 1872-0020 | 20 |
| 1872-0024 | 24 |

Plaque à lame inclinée Plaque à 90°
avec vis Ø 3,5 - Ø 4,0 mm



| RÉF. NON | LONGUEUR / TROUS (mm) |
|-----------|-----------------------|
| 1232-2803 | 28/3 |
| 1232-2804 | 28/4 |
| 1232-2805 | 28/5 |
| 1232-2806 | 28/6 |
| 1232-2807 | 28/7 |
| 1232-2808 | 28/8 |
| 1232-3303 | 33/3 |
| 1232-3304 | 33/4 |
| 1232-3305 | 33/5 |
| 1232-3306 | 33/6 |
| 1232-3307 | 33/7 |
| 1232-3308 | 33/8 |
| 1232-3803 | 38/3 |
| 1232-3804 | 38/4 |
| 1232-3805 | 38/5 |
| 1232-3806 | 38/6 |
| 1232-3807 | 38/7 |
| 1232-3808 | 38/8 |

Plaque de lame inclinée Plaque à 135°
avec vis Ø 3,5 - Ø 4,0 mm



| RÉF. NON | LONGUEUR / TROUS (mm) |
|-----------|-----------------------|
| 1112-2803 | 28/3 |
| 1112-2804 | 28/4 |
| 1112-2805 | 28/5 |
| 1112-2806 | 28/6 |
| 1112-2807 | 28/7 |
| 1112-2808 | 28/8 |
| 1112-3303 | 33/3 |
| 1112-3304 | 33/4 |
| 1112-3305 | 33/5 |
| 1112-3306 | 33/6 |
| 1112-3307 | 33/7 |
| 1112-3308 | 33/8 |
| 1112-3803 | 38/3 |
| 1112-3804 | 38/4 |
| 1112-3805 | 38/5 |
| 1112-3806 | 38/6 |
| 1112-3807 | 38/7 |
| 1112-3808 | 38/8 |





Systemes de plaques

Systeme de plaque de verrouillage pour petits fragments

Plaque de reconstruction droite verrouillable
avec vis \varnothing 3,5 mm



| RÉF. NON | TROUS |
|-----------|-------|
| 1422-0003 | 3 |
| 1422-0004 | 4 |
| 1422-0005 | 5 |
| 1422-0006 | 6 |
| 1422-0007 | 7 |
| 1422-0008 | 8 |
| 1422-0009 | 9 |
| 1422-0010 | 10 |
| 1422-0012 | 12 |
| 1422-0014 | 14 |
| 1422-0016 | 16 |
| 1422-0018 | 18 |
| 1422-0020 | 20 |

| RÉF. NON | TROUS |
|-----------|-------|
| 1932-0004 | 4 |
| 1932-0005 | 5 |
| 1932-0006 | 6 |
| 1932-0007 | 7 |
| 1932-0008 | 8 |
| 1932-0009 | 9 |
| 1932-0010 | 10 |
| 1932-0011 | 11 |
| 1932-0012 | 12 |
| 1932-0013 | 13 |
| 1932-0014 | 14 |
| 1932-0015 | 15 |
| 1932-0016 | 16 |

Plaque de reconstruction courbée
avec vis \varnothing 3,5 mm

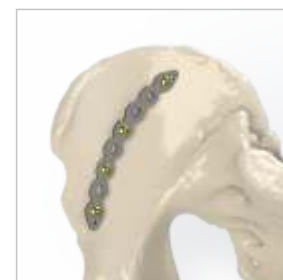

Plaque à crochet acétabulaire
avec vis \varnothing 3,5 mm



| RÉF. NON | TROUS |
|-----------|-------|
| 9802-0002 | 2 |
| 9802-0003 | 3 |
| 9802-0004 | 4 |
| 9802-0005 | 5 |
| 9802-0006 | 6 |

Symphyse pubienne
Plaque pelvienne
avec vis \varnothing 3,5 mm



| RÉF. NON | TROUS | TAILLE |
|-----------|-------|--------|
| 9742-0010 | 4 | S |
| 9742-0030 | 4 | M |
| 9742-0020 | 4 | L |

Plaque sacro-iliaque supérieure
avec vis \varnothing 3,5 mm



| RÉF. NON |
|-----------|
| 9192-0010 |

Systèmes de plaques

Système de plaque de verrouillage pour petits fragments



Plaque acétabulaire de la paroi postérieure
avec vis Ø 3,5 mm

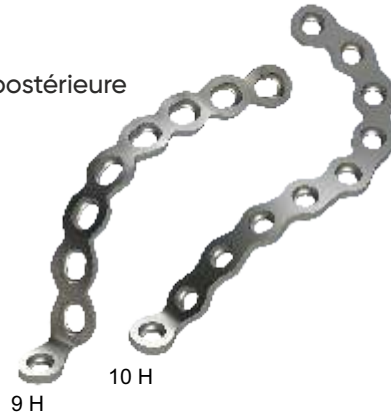

| RÉF. NON | TROUS |
|-----------|-------|
| 9612-1009 | 9-D |
| 9612-1010 | 10-D |
| 9612-2009 | 9-G |
| 9612-2010 | 10-G |

| RÉF. NON | TROUS |
|-----------|-------|
| 9592-1012 | 12-D |
| 9592-2012 | 12-G |



Plaque pelvienne ilio-pectinée
avec vis Ø 3,5 mm



Plaque pelvienne à bord antérieur
avec vis Ø 3,5 mm



| RÉF. NON | TROUS |
|-----------|-------|
| 1092-1013 | 13-D |
| 1092-2013 | 13-G |



| RÉF. NON | TROUS |
|-----------|-------|
| 1942-0023 | 23 |

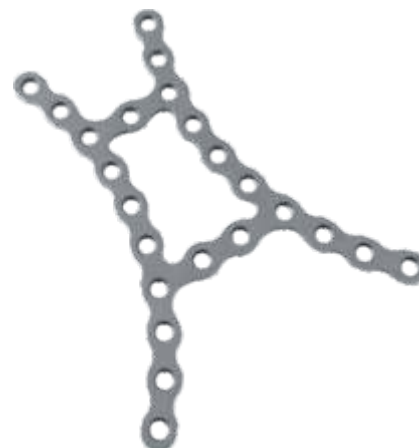

Plaque pelvienne papillon verrouillable
avec vis Ø 3,5 mm





Systèmes de plaques

Système de plaque de verrouillage pour petits fragments

Plaque de verrouillage pour clavicule distale
avec vis \varnothing 3,5 - \varnothing 4,0 mm

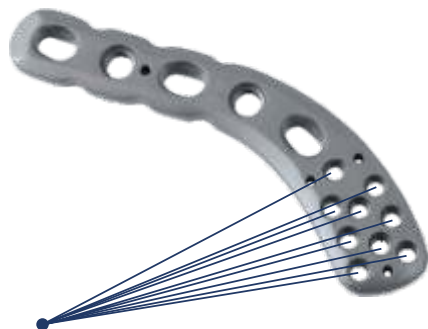

Vis de blocage \varnothing 2,4 mm

| RÉF. NON | TROUS |
|-----------|-------|
| 1492-1014 | 14-D |
| 1492-1017 | 17-D |
| 1492-2014 | 14-G |
| 1492-2017 | 17-G |

| RÉF. NON | TROUS |
|-----------|-------|
| 1632-1006 | 6-D |
| 1632-1008 | 8-D |
| 1632-1010 | 10-D |
| 1632-1012 | 12-D |
| 1632-2006 | 6-G |
| 1632-2008 | 8-G |
| 1632-2010 | 10-G |
| 1632-2012 | 12-G |

Plaque de verrouillage pour clavicule

avec vis \varnothing 3,5 - \varnothing 4,0 mm



Plaque à crochet verrouillable pour clavicule

avec vis \varnothing 3,5 - \varnothing 4,0 mm



| RÉF. NON | TROUS |
|-----------|-------|
| 1622-1005 | 5-D |
| 1622-1007 | 7-D |
| 1622-1009 | 9-D |
| 1622-2005 | 5-G |
| 1622-2007 | 7-G |
| 1622-2009 | 9-G |

| RÉF. NON | TROUS |
|-----------|-------|
| 1702-0020 | 20 |
| 1702-0022 | 22 |

Plaque de verrouillage du pylône

avec vis \varnothing 3,5 - \varnothing 4,0 mm



Systemes de plaques

Systeme de plaque de verrouillage pour petits fragments



Plaque fibulaire distale verrouillable

avec vis \varnothing 3,5 - \varnothing 4,0 mm



| RÉF. NON | TROUS |
|-----------|-------|
| 1852-1009 | 9-D |
| 1852-1011 | 11-D |
| 1852-1013 | 13-D |
| 1852-2009 | 9-G |
| 1852-2011 | 11-G |
| 1852-2013 | 13-G |

| RÉF. NON | TROUS |
|-----------|-------|
| 1842-1009 | 9-D |
| 1842-1011 | 11-D |
| 1842-1013 | 13-D |
| 1842-1015 | 15-D |
| 1842-1017 | 17-D |
| 1842-2009 | 9-G |
| 1842-2011 | 11-G |
| 1842-2013 | 13-G |
| 1842-2015 | 15-G |
| 1842-2017 | 17-G |

Plaque fibulaire latérale distale verrouillable

avec vis \varnothing 3,5 - \varnothing 4,0 mm

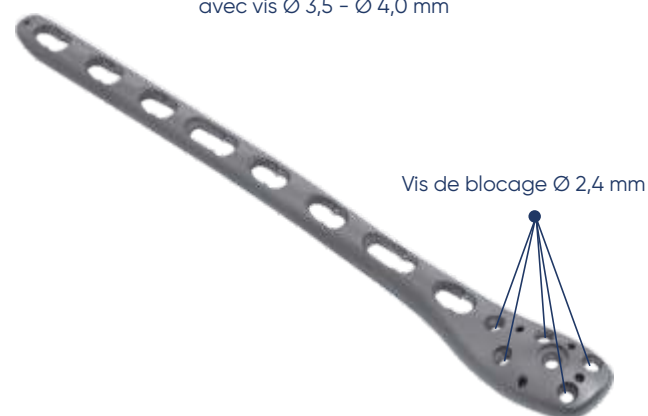

Plaque calcanéenne verrouillable F

with \varnothing 3,5 - \varnothing 4.0 mm screw



| RÉF. NON | LONGUEUR (mm) |
|-----------|---------------|
| 1602-1046 | 46-D |
| 1602-1060 | 60-D |
| 1602-1070 | 70-D |
| 1602-2046 | 46-G |
| 1602-2060 | 60-G |
| 1602-2070 | 70-G |

Plaque calcanéenne verrouillable en Y

with \varnothing 3,5 - \varnothing 4.0 mm screw



| RÉF. NON | LONGUEUR (mm) |
|-----------|---------------|
| 8862-1046 | 46-D |
| 8862-1060 | 60-D |
| 8862-1070 | 70-D |
| 8862-2046 | 46-D |
| 8862-2060 | 60-D |
| 8862-2070 | 70-D |

Plaque calcanéenne latérale verrouillable

avec vis \varnothing 3,5 - \varnothing 4,0 mm

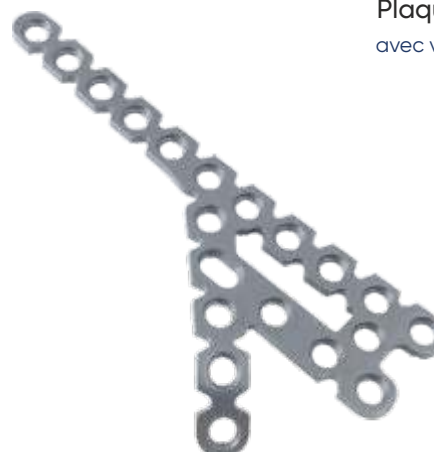

| RÉF. NON | TROUS |
|-----------|-------|
| 1612-1018 | 18-R |
| 1612-1020 | 20-R |
| 1612-2018 | 18-L |
| 1612-2020 | 20-L |

Systèmes de plaques

Système de plaque de verrouillage pour petits fragments



Plaque d'ostéotomie réglable verrouillable pour tibia haut Type II

avec vis \varnothing 4,5 - \varnothing 5,0 mm



Plaque de coin d'ostéotomie réglable et verrouillable pour tibia haut



| RÉF. NON | LONGUEUR (mm) |
|-----------|---------------|
| 1972-0006 | 6 |
| 1972-0008 | 8 |
| 1972-0010 | 10 |
| 1972-0012 | 12 |
| 1972-0014 | 14 |

Vis de blocage \varnothing 6,5 mm en spongieux

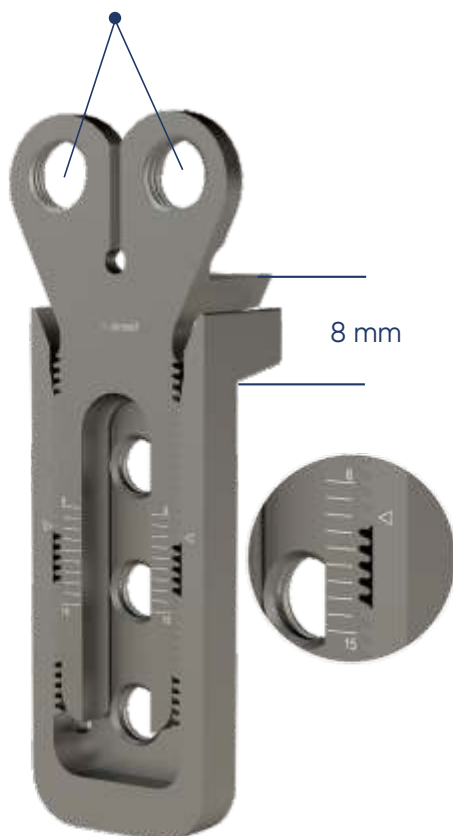

Plaque d'ostéotomie verrouillable réglable pour tibia haut de type I

avec vis \varnothing 4,5 - \varnothing 5,0 mm



| REF. NO |
|-----------|
| 1972-0015 |



| RÉF. NON |
|-----------|
| 1972-0020 |



Systemes de plaques

Systeme de plaque de verrouillage pour petits fragments

Plaque rotulienne



| RÉF. NON | TAILLE |
|-----------|--------|
| 1072-0001 | S |
| 1072-0002 | M |
| 1072-0003 | L |

Plaque pour coude (arthrodèse)

avec vis \varnothing 3,5 - \varnothing 4,0 mm



| RÉF. NON | TROUS |
|-----------|-------|
| 1222-0010 | 20 |



Vis

Système de plaque de verrouillage pour petits fragments

Vis de verrouillage (Ø 3.5 mm)



| RÉF. NON | LONGUEUR (mm) |
|-----------|------------------|
| 2052-3512 | 12 |
| 2052-3514 | 14 |
| 2052-3516 | 16 |
| 2052-3518 | 18 |
| 2052-3520 | 20 |
| 2052-3522 | 22 |
| 2052-3524 | 24 |
| 2052-3526 | 26 |
| 2052-3528 | 28 |
| 2052-3530 | 30 |
| 2052-3532 | 32 |
| 2052-3534 | 34 |
| 2052-3536 | 36 |
| 2052-3538 | 38 |
| 2052-3540 | 40 |
| 2052-3542 | 42 |
| 2052-3544 | 44 |
| 2052-3546 | 46 |
| 2052-3548 | 48 |
| 2052-3550 | 50 |
| 2052-3555 | 55 |
| 2052-3560 | 60 |
| 2052-3565 | 65 |
| 2052-3570 | 70 |

Vis canulées verrouillables (Ø 3.5 mm)



| RÉF. NON | LONGUEUR (mm) |
|-----------|------------------|
| 2412-3512 | 12 |
| 2412-3514 | 14 |
| 2412-3516 | 16 |
| 2412-3518 | 18 |
| 2412-3520 | 20 |
| 2412-3522 | 22 |
| 2412-3524 | 24 |
| 2412-3526 | 26 |
| 2412-3528 | 28 |
| 2412-3530 | 30 |
| 2412-3532 | 32 |
| 2412-3534 | 34 |
| 2412-3536 | 36 |
| 2412-3538 | 38 |
| 2412-3540 | 40 |
| 2412-3542 | 42 |
| 2412-3544 | 44 |
| 2412-3546 | 46 |
| 2412-3548 | 48 |
| 2412-3550 | 50 |
| 2412-3555 | 55 |

Vis spongieuse de blocage (Ø 4.0 mm)



| RÉF. NON | LONGUEUR (mm) |
|-----------|------------------|
| 2152-4012 | 12 |
| 2152-4014 | 14 |
| 2152-4016 | 16 |
| 2152-4018 | 18 |
| 2152-4020 | 20 |
| 2152-4022 | 22 |
| 2152-4024 | 24 |
| 2152-4026 | 26 |
| 2152-4028 | 28 |
| 2152-4030 | 30 |
| 2152-4032 | 32 |
| 2152-4034 | 34 |
| 2152-4036 | 36 |
| 2152-4038 | 38 |
| 2152-4040 | 40 |
| 2152-4042 | 42 |
| 2152-4044 | 44 |
| 2152-4046 | 46 |
| 2152-4048 | 48 |
| 2152-4050 | 50 |

Vis de verrouillage de l'adaptateur de câble



| RÉF. NON | LONGUEUR (mm) |
|-----------|------------------|
| 2602-3500 | 3.5 |

Bouchon à vis de verrouillage



| RÉF. NON | LONGUEUR (mm) |
|-----------|------------------|
| 2052-3500 | 3.5 |

Vis

Système de plaque de verrouillage pour petits fragments

Vis spongieuse (Ø 4.0 mm) (fileté 1/3 mm)



| RÉF. NON | LONGUEUR (mm) |
|-----------|------------------|
| 2932-4012 | 12 |
| 2932-4014 | 14 |
| 2932-4016 | 16 |
| 2932-4018 | 18 |
| 2932-4020 | 20 |
| 2932-4022 | 22 |
| 2932-4024 | 24 |
| 2932-4026 | 26 |
| 2932-4028 | 28 |
| 2932-4030 | 30 |
| 2932-4032 | 32 |
| 2932-4034 | 34 |
| 2932-4036 | 36 |
| 2932-4038 | 38 |
| 2932-4040 | 40 |
| 2932-4042 | 42 |
| 2932-4044 | 44 |
| 2932-4046 | 46 |
| 2932-4048 | 48 |
| 2932-4050 | 50 |

Vis corticale (Ø 3.5 mm)



| RÉF. NON | LONGUEUR (mm) |
|-----------|------------------|
| 2012-3512 | 12 |
| 2012-3514 | 14 |
| 2012-3516 | 16 |
| 2012-3518 | 18 |
| 2012-3520 | 20 |
| 2012-3522 | 22 |
| 2012-3524 | 24 |
| 2012-3526 | 26 |
| 2012-3528 | 28 |
| 2012-3530 | 30 |
| 2012-3532 | 32 |
| 2012-3534 | 34 |
| 2012-3536 | 36 |
| 2012-3538 | 38 |
| 2012-3540 | 40 |
| 2012-3542 | 42 |
| 2012-3544 | 44 |
| 2012-3546 | 46 |
| 2012-3548 | 48 |
| 2012-3550 | 50 |
| 2012-3552 | 52 |
| 2012-3555 | 55 |
| 2012-3560 | 60 |
| 2012-3565 | 65 |
| 2012-3570 | 70 |
| 2012-3575 | 75 |
| 2012-3580 | 80 |
| 2012-3585 | 85 |
| 2012-3590 | 90 |
| 2012-3595 | 95 |
| 2012-3100 | 100 |
| 2012-3105 | 105 |
| 2012-3110 | 110 |
| 2012-3115 | 115 |
| 2012-3120 | 120 |



Vis

Système de plaque de verrouillage pour petits fragments

Vis corticale (Ø 2.4 mm)



| RÉF. NON | LONGUEUR (mm) |
|-----------|------------------|
| 2072-2410 | 10 |
| 2072-2412 | 12 |
| 2072-2414 | 14 |
| 2072-2416 | 16 |
| 2072-2418 | 18 |
| 2072-2420 | 20 |
| 2072-2422 | 22 |
| 2072-2424 | 24 |
| 2072-2426 | 26 |
| 2072-2428 | 28 |
| 2072-2430 | 30 |

Vis de verrouillage (Ø 2.4 mm)



| RÉF. NON | LONGUEUR (mm) |
|-----------|------------------|
| 2342-2410 | 10 |
| 2342-2412 | 12 |
| 2342-2414 | 14 |
| 2342-2416 | 16 |
| 2342-2418 | 18 |
| 2342-2420 | 20 |
| 2342-2422 | 22 |
| 2342-2424 | 24 |
| 2342-2426 | 26 |
| 2342-2428 | 28 |
| 2342-2430 | 30 |

Vis malléolaires (Ø 4.5 mm)



| RÉF. NON | LONGUEUR (mm) |
|-----------|------------------|
| 2092-0025 | 25 |
| 2092-0030 | 30 |
| 2092-0035 | 35 |
| 2092-0040 | 40 |
| 2092-0045 | 45 |
| 2092-0050 | 50 |
| 2092-0055 | 55 |
| 2092-0060 | 60 |
| 2092-0065 | 65 |
| 2092-0070 | 70 |
| 2092-0075 | 75 |
| 2092-0080 | 80 |
| 2092-0085 | 85 |



Vis

Système de plaque de verrouillage pour petits fragments



Vis canulées (Ø 3.5 mm)



| RÉF. NON | LONGUEUR (mm) |
|-----------|------------------|
| 2162-0012 | 12 |
| 2162-0014 | 14 |
| 2162-0016 | 16 |
| 2162-0018 | 18 |
| 2162-0020 | 20 |
| 2162-0022 | 22 |
| 2162-0024 | 24 |
| 2162-0026 | 26 |
| 2162-0028 | 28 |
| 2162-0030 | 30 |
| 2162-0032 | 32 |
| 2162-0034 | 34 |
| 2162-0036 | 36 |
| 2162-0038 | 38 |
| 2162-0040 | 40 |
| 2162-0042 | 42 |
| 2162-0044 | 44 |
| 2162-0046 | 46 |
| 2162-0048 | 48 |
| 2162-0050 | 50 |

la rondelle

Ø73 mm - Ø4.5 mm - Ø3.5 mm



| RÉF. NON | LONGUEUR (mm) |
|-----------|------------------|
| 2012-0035 | 3.5 |
| 2012-0045 | 4.5 |
| 2042-0073 | 73 |

Vis canulées (Ø 4.5 mm)



| RÉF. NON | LONGUEUR (mm) |
|-----------|------------------|
| 2032-0022 | 22 |
| 2032-0024 | 24 |
| 2032-0026 | 26 |
| 2032-0028 | 28 |
| 2032-0030 | 30 |
| 2032-0032 | 32 |
| 2032-0034 | 34 |
| 2032-0036 | 36 |
| 2032-0038 | 38 |
| 2032-0040 | 40 |
| 2032-0042 | 42 |
| 2032-0044 | 44 |
| 2032-0046 | 46 |
| 2032-0048 | 48 |
| 2032-0050 | 50 |
| 2032-0052 | 52 |
| 2032-0054 | 54 |
| 2032-0056 | 56 |
| 2032-0058 | 58 |
| 2032-0060 | 60 |

Vis canulées (Ø 73 mm) (Fileté 16 mm)



| RÉF. NON | LONGUEUR (mm) |
|-----------|------------------|
| 2042-0050 | 50 |
| 2042-0055 | 55 |
| 2042-0060 | 60 |
| 2042-0065 | 65 |
| 2042-0070 | 70 |
| 2042-0075 | 75 |
| 2042-0080 | 80 |
| 2042-0085 | 85 |
| 2042-0090 | 90 |
| 2042-0095 | 95 |
| 2042-0100 | 100 |
| 2042-0105 | 105 |
| 2042-0110 | 110 |
| 2042-0115 | 115 |
| 2042-0120 | 120 |

Cannulated Screws (Ø 73 mm) (32 mm Threaded)



| RÉF. NON | LONGUEUR (mm) |
|-----------|------------------|
| 2252-0050 | 50 |
| 2252-0055 | 55 |
| 2252-0060 | 60 |
| 2252-0065 | 65 |
| 2252-0070 | 70 |
| 2252-0075 | 75 |
| 2252-0080 | 80 |
| 2252-0085 | 85 |
| 2252-0090 | 90 |
| 2252-0095 | 95 |
| 2252-0100 | 100 |
| 2252-0105 | 105 |
| 2252-0110 | 110 |
| 2252-0115 | 115 |
| 2252-0120 | 120 |

Vis de Herbert canulées (Ø 3.0 mm)



| RÉF. NON | LONGUEUR (mm) |
|-----------|------------------|
| 2172-0010 | 10 |
| 2172-0012 | 12 |
| 2172-0014 | 14 |
| 2172-0016 | 16 |
| 2172-0018 | 18 |
| 2172-0020 | 20 |
| 2172-0022 | 22 |
| 2172-0024 | 24 |
| 2172-0026 | 26 |
| 2172-0028 | 28 |
| 2172-0030 | 30 |

Vis canulées sans tête
(Ø 2.5 mm)

| RÉF. NON | LONGUEUR (mm) |
|-----------|---------------|
| 2362-2508 | 8 |
| 2362-2510 | 10 |
| 2362-2512 | 12 |
| 2362-2514 | 14 |
| 2362-2516 | 16 |
| 2362-2518 | 18 |
| 2362-2520 | 20 |



Vis canulées sans tête
(Ø 3.5 mm)

| RÉF. NON | LONGUEUR (mm) |
|-----------|---------------|
| 2362-3516 | 16 |
| 2362-3518 | 18 |
| 2362-3520 | 20 |
| 2362-3522 | 22 |
| 2362-3524 | 24 |
| 2362-3526 | 26 |
| 2362-3528 | 28 |
| 2362-3530 | 30 |
| 2362-3532 | 32 |
| 2362-3534 | 34 |
| 2362-3536 | 36 |
| 2362-3538 | 38 |
| 2362-3540 | 40 |



Vis canulées sans tête
(Ø 4.0 mm)

| RÉF. NON | LONGUEUR (mm) |
|-----------|---------------|
| 2362-4016 | 16 |
| 2362-4018 | 18 |
| 2362-4020 | 20 |
| 2362-4022 | 22 |
| 2362-4024 | 24 |
| 2362-4026 | 26 |
| 2362-4028 | 28 |
| 2362-4030 | 30 |
| 2362-4032 | 32 |
| 2362-4034 | 34 |
| 2362-4036 | 36 |
| 2362-4038 | 38 |
| 2362-4040 | 40 |



Vis canulées sans tête
(Ø 5.0 mm)

| RÉF. NON | LONGUEUR (mm) |
|-----------|---------------|
| 2362-5025 | 25 |
| 2362-5030 | 30 |
| 2362-5035 | 35 |
| 2362-5040 | 40 |
| 2362-5045 | 45 |
| 2362-5050 | 50 |



Vis canulées sans tête
(Ø 6.5 mm)

| RÉF. NON | LONGUEUR (mm) |
|-----------|---------------|
| 2362-6035 | 35 |
| 2362-6040 | 40 |
| 2362-6045 | 45 |
| 2362-6050 | 50 |
| 2362-6055 | 55 |
| 2362-6060 | 60 |
| 2362-6065 | 65 |
| 2362-6070 | 70 |
| 2362-6075 | 75 |
| 2362-6080 | 80 |
| 2362-6085 | 85 |
| 2362-6090 | 90 |
| 2362-6095 | 95 |





Systemes de plaques

Systemes de mini-plaques verrouillables

Plaque droite verrouillable LCP
2.0 mm



| RÉF. NON | TROUS |
|--------------|-------|
| OP.1012-0004 | 4 |
| OP.1012-0005 | 5 |
| OP.1012-0006 | 6 |
| OP.1012-0007 | 7 |
| OP.1012-0008 | 8 |

Plaque en T verrouillable LCP Type I
2.0 mm



| RÉF. NON | TROUS |
|--------------|-------|
| OP.1032-0023 | 2+3 |
| OP.1032-0025 | 2+5 |
| OP.1032-0027 | 2+7 |

Plaque en T LCP verrouillable
2.0 mm



| RÉF. NON | TROUS |
|--------------|-------|
| OP.1052-0033 | 3+3 |
| OP.1052-0035 | 3+5 |
| OP.1052-0037 | 3+7 |

Plaque Y LCP verrouillable
2.0 mm



| RÉF. NON | TROUS |
|--------------|-------|
| OP.1062-0033 | 3+3 |
| OP.1062-0035 | 3+5 |
| OP.1062-0037 | 3+7 |

Vis à corticale
Ø 2.0 mm



| RÉF. NON | LONGUEUR (mm) |
|--------------|---------------|
| OS.2012-2006 | 6 |
| OS.2012-2007 | 7 |
| OS.2012-2008 | 8 |
| OS.2012-2009 | 9 |
| OS.2012-2010 | 10 |
| OS.2012-2011 | 11 |
| OS.2012-2012 | 12 |
| OS.2012-2013 | 13 |
| OS.2012-2014 | 14 |
| OS.2012-2015 | 15 |
| OS.2012-2016 | 16 |
| OS.2012-2017 | 17 |
| OS.2012-2018 | 18 |
| OS.2012-2019 | 19 |
| OS.2012-2020 | 20 |
| OS.2012-2022 | 22 |
| OS.2012-2024 | 24 |
| OS.2012-2026 | 26 |
| OS.2012-2028 | 28 |
| OS.2012-2030 | 30 |

Vis de verrouillage
Ø 2.0 mm



| RÉF. NON | LONGUEUR (mm) |
|--------------|---------------|
| OS.2022-2006 | 6 |
| OS.2022-2007 | 7 |
| OS.2022-2008 | 8 |
| OS.2022-2009 | 9 |
| OS.2022-2010 | 10 |
| OS.2022-2011 | 11 |
| OS.2022-2012 | 12 |
| OS.2022-2013 | 13 |
| OS.2022-2014 | 14 |
| OS.2022-2015 | 15 |
| OS.2022-2016 | 16 |
| OS.2022-2017 | 17 |
| OS.2022-2018 | 18 |
| OS.2022-2019 | 19 |
| OS.2022-2020 | 20 |
| OS.2022-2022 | 22 |
| OS.2022-2024 | 24 |
| OS.2022-2026 | 26 |
| OS.2022-2028 | 28 |
| OS.2022-2030 | 30 |

Plaque en T verrouillable LCP Type II
2.0 mm



| RÉF. NON | TROUS |
|--------------|-------|
| OP.1042-0023 | 2+3 |
| OP.1042-0025 | 2+5 |
| OP.1042-0027 | 2+7 |

Plaque de reconstruction LCP verrouillable
2.0 mm



| RÉF. NON | TROUS |
|--------------|-------|
| OP.1022-0006 | 6 |
| OP.1022-0012 | 12 |

Systèmes de plaques

Systèmes de mini-plaques verrouillables



Plaque droite verrouillable LCP
2.4 mm



| RÉF. NON | TROUS |
|--------------|-------|
| OP:1072-0004 | 4 |
| OP:1072-0005 | 5 |
| OP:1072-0006 | 6 |
| OP:1072-0007 | 7 |
| OP:1012-0008 | 8 |
| OP:1072-0010 | 10 |

Plaque de phalange en T de type I
2.4 mm



| RÉF. NON | TROUS |
|--------------|-------|
| OP:1092-0023 | 2+3 |
| OP:1092-0025 | 2+5 |
| OP:1092-0027 | 2+7 |

Plaque en T LCP verrouillable
2.4 mm



| RÉF. NON | TROUS |
|--------------|-------|
| OP:1112-0033 | 3+3 |
| OP:1112-0035 | 3+5 |
| OP:1112-0037 | 3+7 |

Plaque Y LCP verrouillable
2.4 mm



| RÉF. NON | TROUS |
|--------------|-------|
| OP:1122-0033 | 3+3 |
| OP:1122-0035 | 3+5 |
| OP:1122-0037 | 3+7 |

Vis à corticale
Ø 2.4 mm



| RÉF. NON | LONGUEUR (mm) |
|--------------|---------------|
| OS.2032-2406 | 6 |
| OS.2032-2407 | 7 |
| OS.2032-2408 | 8 |
| OS.2032-2409 | 9 |
| OS.2032-2410 | 10 |
| OS.2032-2411 | 11 |
| OS.2032-2412 | 12 |
| OS.2032-2413 | 13 |
| OS.2032-2414 | 14 |
| OS.2032-2415 | 15 |
| OS.2032-2416 | 16 |
| OS.2032-2417 | 17 |
| OS.2032-2418 | 18 |
| OS.2032-2419 | 19 |
| OS.2032-2420 | 20 |
| OS.2032-2422 | 22 |
| OS.2032-2424 | 24 |
| OS.2032-2426 | 26 |
| OS.2032-2428 | 28 |
| OS.2032-2430 | 30 |

Vis de verrouillage
Ø 2.4 mm



| RÉF. NON | LONGUEUR (mm) |
|--------------|---------------|
| OS.2042-2406 | 6 |
| OS.2042-2407 | 7 |
| OS.2042-2408 | 8 |
| OS.2042-2409 | 9 |
| OS.2042-2410 | 10 |
| OS.2042-2411 | 11 |
| OS.2042-2412 | 12 |
| OS.2042-2413 | 13 |
| OS.2042-2414 | 14 |
| OS.2042-2415 | 15 |
| OS.2042-2416 | 16 |
| OS.2042-2417 | 17 |
| OS.2042-2418 | 18 |
| OS.2042-2419 | 19 |
| OS.2042-2420 | 20 |
| OS.2042-2422 | 22 |
| OS.2042-2424 | 24 |
| OS.2042-2426 | 26 |
| OS.2042-2428 | 28 |
| OS.2042-2430 | 30 |

Plaque de phalange en T de type II
2.4 mm



| RÉF. NON | TROUS |
|--------------|-------|
| OP:1102-0023 | 2+3 |
| OP:1102-0025 | 2+5 |
| OP:1102-0027 | 2+7 |

Plaque de reconstruction droite LCP verrouillable
2.4 mm



| RÉF. NON | TROUS |
|--------------|-------|
| OP:1082-0006 | 6 |
| OP:1082-0012 | 12 |



Systemes de plaques

Plaques de verrouillage DHS-DCS



Plaque de verrouillage DHS 135°

avec vis \varnothing 5,0 - \varnothing 4,5 - \varnothing 6,5 mm

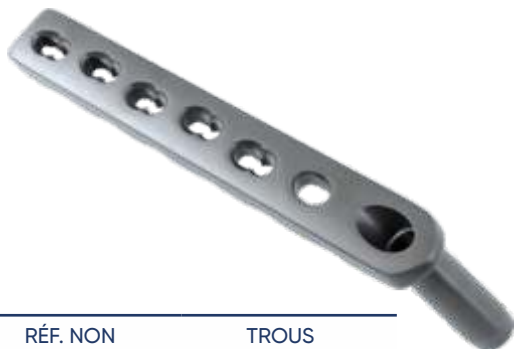

| RÉF. NON | TROUS |
|-----------|-------|
| 1732-0002 | 2 |
| 1732-0003 | 3 |
| 1732-0004 | 4 |
| 1732-0005 | 5 |
| 1732-0006 | 6 |
| 1732-0007 | 7 |
| 1732-0008 | 8 |
| 1732-0009 | 9 |
| 1732-0010 | 10 |
| 1732-0011 | 11 |
| 1732-0012 | 12 |
| 1732-0014 | 14 |
| 1732-0015 | 15 |
| 1732-0016 | 16 |

Plaque DCS verrouillable à 95°

avec vis \varnothing 5,0 - \varnothing 4,5 - \varnothing 6,5 mm



| RÉF. NON | TROUS |
|-----------|-------|
| 1742-0003 | 3 |
| 1742-0004 | 4 |
| 1742-0005 | 5 |
| 1742-0006 | 6 |
| 1742-0007 | 7 |
| 1742-0008 | 8 |
| 1742-0009 | 9 |
| 1742-0010 | 10 |
| 1742-0011 | 11 |
| 1742-0012 | 12 |
| 1742-0013 | 13 |
| 1742-0014 | 14 |
| 1742-0016 | 16 |

Vis à tête creuse DHS / DCS

| RÉF. NON | LONGUEUR (mm) |
|-----------|---------------|
| 1062-0050 | 50 |
| 1062-0055 | 55 |
| 1062-0060 | 60 |
| 1062-0065 | 65 |
| 1062-0070 | 70 |
| 1062-0075 | 75 |
| 1062-0080 | 80 |
| 1062-0085 | 85 |
| 1062-0090 | 90 |
| 1062-0095 | 95 |
| 1062-0100 | 100 |
| 1062-0105 | 105 |
| 1062-0110 | 110 |
| 1062-0115 | 115 |



Vis de compression à retardement DHS/DCS



| REF. NO |
|-----------|
| 1772-0000 |





Systèmes de plaques



Systèmes d'arthroplastie⁺

| | |
|--|----|
| Prothèse de l'articulation de la hanche | 34 |
| Révision de prothèse de hanche | 37 |
| Prothèse totale de l'articulation du genou | 39 |
| Genou Vision-R | 42 |

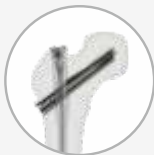

Systèmes de clous



Systèmes de fixation externes

Broches et fils squelettiques

Systèmes spinaux

Arthroscopie

ARTHROPLASTY



Systèmes d'arthroplastie

Prothèse de l'articulation de la hanche

Tige de sablage de remplacement Calcar (cimentée)



| RÉF. NON (SS)acier inoxydable | RÉF. NON (Alliage CoCrMo) Molibden au chrome de cobalt | TAILLE (mm) |
|----------------------------------|--|----------------|
| 7031-0251 | 7033-0251 | 25-9 |
| 7031-0252 | 7033-0252 | 25-11 |
| 7031-0253 | 7033-0253 | 25-13 |
| 7031-0351 | 7033-0351 | 35-09 |
| 7031-0352 | 7033-0352 | 35-11 |
| 7031-0353 | 7033-0353 | 35-13 |
| - | 7033-0355 | 35-15 |
| - | 7033-0356 | 35-16 |
| - | 7033-0357 | 35-17 |
| 7031-0451 | 7033-0451 | 45-09 |
| 7031-0452 | 7033-0452 | 45-11 |
| 7031-0453 | 7033-0453 | 45-13 |
| 7031-0551 | 7033-0551 | 55-09 |
| 7031-0552 | 7033-0552 | 55-11 |
| 7031-0553 | 7033-0553 | 55-13 |

Tige de rechange Calcar à double revêtement (Sans ciment)



| RÉF. NON (Alliage CoCrMo) Molibden au chrome de cobalt | TAILLE (mm) |
|--|----------------|
| 7033-3251 | 25/9 |
| 7033-3252 | 25/11 |
| 7033-3253 | 25/13 |
| 7033-3351 | 35/9 |
| 7033-3352 | 35/11 |
| 7033-3353 | 35/13 |
| 7033-3355 | 35/15 |
| 7033-3356 | 35/16 |
| 7033-3357 | 35/17 |
| 7033-3451 | 45/9 |
| 7033-3452 | 45/11 |
| 7033-3453 | 45/13 |
| 7033-3551 | 55/9 |
| 7033-3552 | 55/11 |
| 7033-3553 | 55/13 |

Tige fémorale (cimentée)



| RÉF. NON (SS)acier inoxydable | RÉF. NON (Alliage CoCrMo) Molibden au chrome de cobalt | TAILLE (mm) |
|----------------------------------|--|----------------|
| 7021-0700 | 7023-0700 | 7 |
| 7021-0800 | 7023-0800 | 8 |
| 7021-0900 | 7023-0900 | 9 |
| 7021-1000 | 7023-1000 | 10 |
| 7021-1100 | 7023-1100 | 11 |
| 7021-1200 | 7023-1200 | 12 |

Tige fémorale à double revêtement (sans ciment)



| RÉF. NON (TI) | TAILLE (mm) |
|------------------|----------------|
| 7022-4075 | 7.5 |
| 7022-4085 | 8.5 |
| 7022-4090 | 9 |
| 7022-4100 | 10 |
| 7022-4110 | 11 |
| 7022-4120 | 12 |
| 7022-4135 | 13.5 |

Centralisateur Distal



| RÉF. NON (UHMWPE) | TAILLE |
|----------------------|--------|
| 7079-0003 | S |
| 7079-0004 | M |

Bouchon de ciment



| RÉF. NON (UHMWPE) | TAILLE (mm) |
|----------------------|----------------|
| 7069-0009 | 9 |
| 7069-0010 | 10 |
| 7069-0011 | 11 |
| 7069-0012 | 12 |
| 7069-0013 | 13 |
| 7069-0014 | 14 |
| 7069-0015 | 15 |
| 7069-0016 | 16 |
| 7069-0017 | 17 |
| 7069-0018 | 18 |

Systèmes d'arthroplastie

Prothèse de l'articulation de la hanche



Cotyle à double revêtement (sans ciment)



| RÉF. NON (Ti) | TAILLE |
|---------------|--------|
| 7132-0042 | 42 |
| 7132-0044 | 44 |
| 7132-0046 | 46 |
| 7132-0048 | 48 |
| 7132-0050 | 50 |
| 7132-0052 | 52 |
| 7132-0054 | 54 |
| 7132-0056 | 56 |
| 7132-0058 | 58 |
| 7132-0060 | 60 |
| 7132-0062 | 62 |

Cupule acétabulaire Poros Revêtue (sans ciment)



| RÉF. NON (Ti) | TAILLE |
|---------------|--------|
| 7112-0042 | 42 |
| 7112-0044 | 44 |
| 7112-0046 | 46 |
| 7112-0048 | 48 |
| 7112-0050 | 50 |
| 7112-0052 | 52 |
| 7112-0054 | 54 |
| 7112-0056 | 56 |
| 7112-0058 | 58 |
| 7112-0060 | 60 |
| 7112-0062 | 62 |

Doublure acétabulaire (10°)



| RÉF. NON (UHMWPE) | RÉF. NON | RÉF. NON (UHMWPE) | RÉF. NON |
|-------------------|----------|-------------------|----------|
| 7159-0042 | 42/22 | 7159-5232 | 52/32 |
| 7159-0044 | 44/22 | 7159-5432 | 54/32 |
| 7159-0046 | 46/22 | 7159-5632 | 56/32 |
| 7159-0048 | 48/28 | 7159-5832 | 58/32 |
| 7159-0050 | 50/28 | 7159-6032 | 60/32 |
| 7159-0052 | 52/28 | 7159-6232 | 62/32 |
| 7159-0054 | 54/28 | 7159-5636 | 56/36 |
| 7159-0056 | 56/28 | 7159-5836 | 58/36 |
| 7159-0058 | 58/28 | 7159-6036 | 60/36 |
| 7159-0060 | 60/28 | 7159-6236 | 62/36 |
| 7159-0062 | 62/28 | | |

Vis acétabulaire



| RÉF. NON (Ti) | LONGUEUR (mm) |
|---------------|---------------|
| 7102-0015 | 15 |
| 7102-0020 | 20 |
| 7102-0025 | 25 |
| 7102-0030 | 30 |
| 7102-0035 | 35 |
| 7102-0040 | 40 |
| 7102-0045 | 45 |

Cotyle (Cimenté) (10°)



| RÉF. NON (UHMWPE) | TAILLE | RÉF. NON (UHMWPE) | TAILLE |
|-------------------|--------|-------------------|--------|
| 7149-0042 | 42/28 | 7149-5036 | 50/36 |
| 7149-0044 | 44/28 | 7149-5236 | 52/36 |
| 7149-0046 | 46/28 | 7149-5436 | 54/36 |
| 7149-0048 | 48/28 | 7149-5636 | 56/36 |
| 7149-0050 | 50/28 | 7149-5836 | 58/36 |
| 7149-0052 | 52/28 | 7149-6036 | 60/36 |
| 7149-0054 | 54/28 | 7149-6236 | 62/36 |
| 7149-0056 | 56/28 | | |
| 7149-0058 | 58/28 | | |
| 7149-0060 | 60/28 | | |
| 7149-0062 | 62/28 | | |

Tête bipolaire



| RÉF. NON (SS)acier inoxydable | RÉF. NON (Alliage CoCrMo) Molybdène au chrome de cobalt | TAILLE | RÉF. NON (SS)acier inoxydable | RÉF. NON (Alliage CoCrMo) Molybdène au chrome de cobalt | TAILLE |
|-------------------------------|---|--------|-------------------------------|---|--------|
| 7051-2238 | 7053-2238 | 38/22 | 7051-2850 | 7053-2850 | 50/28 |
| 7051-2840 | 7053-2840 | 40/28 | 7051-2852 | 7053-2852 | 52/28 |
| 7051-2842 | 7053-2842 | 42/28 | 7051-2854 | 7053-2854 | 54/28 |
| 7051-2844 | 7053-2844 | 44/28 | 7051-2856 | 7053-2856 | 56/28 |
| 7051-2846 | 7053-2846 | 46/28 | 7051-2858 | 7053-2858 | 58/28 |
| 7051-2848 | 7053-2848 | 48/28 | | | |





Systemes d'arthroplastie

Prothèse de l'articulation de la hanche

Tête fémorale modulaire Ø 22 mm
12/14 mm



| RÉF. NON (SS)acier inoxydable | RÉF. NON (Alliage CoCrMo) Molibden au chrome de cobalt | TAILLE |
|----------------------------------|--|----------|
| 7041-0220 | 7043-0220 | 22+0 (M) |
| 7041-0224 | 7043-0224 | 22+4 (L) |

Tête fémorale modulaire Ø 28 mm
12/14 mm



| RÉF. NON (SS)acier inoxydable | RÉF. NON (Alliage CoCrMo) Molibden au chrome de cobalt | TAILLE |
|----------------------------------|--|------------|
| 7041-0283 | 7043-0283 | 28-3 (S) |
| 7041-0280 | 7043-0280 | 28+0 (M) |
| 7041-0284 | 7043-0284 | 28+4 (L) |
| 7041-0286 | 7043-0286 | 28+6 (XL) |
| 7041-0288 | 7043-0288 | 28+8 (XXL) |

Tête fémorale modulaire Ø 32 mm
12/14 mm



| RÉF. NON acier inoxydable | RÉF. NON (Alliage CoCrMo) Molibden au chrome de cobalt | TAILLE |
|------------------------------|--|------------|
| 7041-0323 | 7043-0323 | 32-3 (S) |
| 7041-0320 | 7043-0320 | 32+0 (M) |
| 7041-0324 | 7043-0324 | 32+4 (L) |
| 7041-0326 | 7043-0326 | 32+6 (XL) |
| 7041-0328 | 7043-0328 | 32+8 (XXL) |

Tête fémorale modulaire Ø 36 mm
12/14 mm



| RÉF. NON (SS)acier inoxydable | RÉF. NON (Alliage CoCrMo) Molibden au chrome de cobalt | TAILLE |
|----------------------------------|--|------------|
| 7041-0363 | 7043-0363 | 36-3 (S) |
| 7041-0360 | 7043-0360 | 36+0 (M) |
| 7041-0364 | 7043-0364 | 36+4 (L) |
| 7041-0366 | 7043-0366 | 36+6 (XL) |
| 7041-0368 | 7043-0368 | 36+8 (XXL) |



Plaque de préhension trochantérienne

| RÉF. NON (Ti) | TAILLE |
|------------------|--------|
| 1712-0001 | S 1H |
| 1712-0002 | M 3H |
| 1712-0003 | L 5H |

Câble

| RÉF. NON (SS)acier inoxydable | RÉF. NON (Ti) | RÉF. NON (Alliage CoCrMo) Molibden au chrome de cobalt | TAILLE (mm) |
|----------------------------------|------------------|--|----------------|
| 6081-2050 | 6082-2050 | 6083-2050 | 2.0X500 |
| 6081-2070 | 6082-2070 | 6083-2070 | 2.0X700 |





Systemes d'arthroplastie

Révision de prothèse de hanche



1 Révision Modulaire Droite Tige de sablage (sans ciment)

| RÉF. NON (TI) | TAILLE |
|------------------|----------|
| R.7232-1212 | 12/120mm |
| R.7232-1312 | 13/120mm |
| R.7232-1412 | 14/120mm |
| R.7232-1512 | 15/120mm |
| R.7232-1612 | 16/120mm |
| R.7232-1712 | 17/120mm |
| R.7232-1812 | 18/120mm |
| R.7232-1912 | 19/120mm |
| R.7232-2012 | 20/120mm |
| R.7232-2112 | 21/120mm |
| R.7232-2212 | 22/120mm |
| R.7232-2312 | 23/120mm |
| R.7232-2412 | 24/120mm |

2 Tige droite modulaire de révision Tige à double revêtement (sans ciment)

| RÉF. NON (TI) | TAILLE |
|------------------|----------|
| R.7182-1212 | 12/120mm |
| R.7182-1312 | 13/120mm |
| R.7182-1412 | 14/120mm |
| R.7182-1512 | 15/120mm |
| R.7182-1612 | 16/120mm |
| R.7182-1712 | 17/120mm |
| R.7182-1812 | 18/120mm |
| R.7182-1912 | 19/120mm |
| R.7182-2012 | 20/120mm |
| R.7182-2112 | 21/120mm |
| R.7182-2212 | 22/120mm |
| R.7182-2312 | 23/120mm |
| R.7182-2412 | 24/120mm |

3 Revision Moduler Proximal Body Sandblasting (Cementless)

| RÉF. NON (TI) | TAILLE |
|------------------|----------|
| R.7302-2070 | 20/70mm |
| R.7302-2080 | 20/80mm |
| R.7302-2090 | 20/90mm |
| R.7302-2010 | 20/100mm |
| R.7302-2011 | 20/110mm |
| R.7302-2370 | 23/70mm |
| R.7302-2380 | 23/80mm |
| R.7302-2390 | 23/90mm |
| R.7302-2310 | 23/100mm |
| R.7302-2311 | 23/110mm |

4 Revision Moduler Proximal Body Dual Coated (Cementless)

| RÉF. NON (TI) | TAILLE |
|------------------|----------|
| R.7272-2070 | 20/70mm |
| R.7272-2080 | 20/80mm |
| R.7272-2090 | 20/90mm |
| R.7272-2010 | 20/100mm |
| R.7272-2011 | 20/110mm |
| R.7272-2370 | 23/70mm |
| R.7272-2380 | 23/80mm |
| R.7272-2390 | 23/90mm |
| R.7272-2310 | 23/100mm |
| R.7272-2311 | 23/110mm |

5 Revision Modular Stem Locking Screw

| RÉF. NON (TI) | TAILLE |
|------------------|--------|
| R.7212-0070 | 70mm |
| R.7212-0080 | 80mm |
| R.7212-0090 | 90mm |
| R.7212-0100 | 100mm |
| R.7212-0110 | 110mm |

Systèmes d'arthroplastie

Révision de prothèse de hanche



Tige fémorale monobloc de révision (sans ciment)

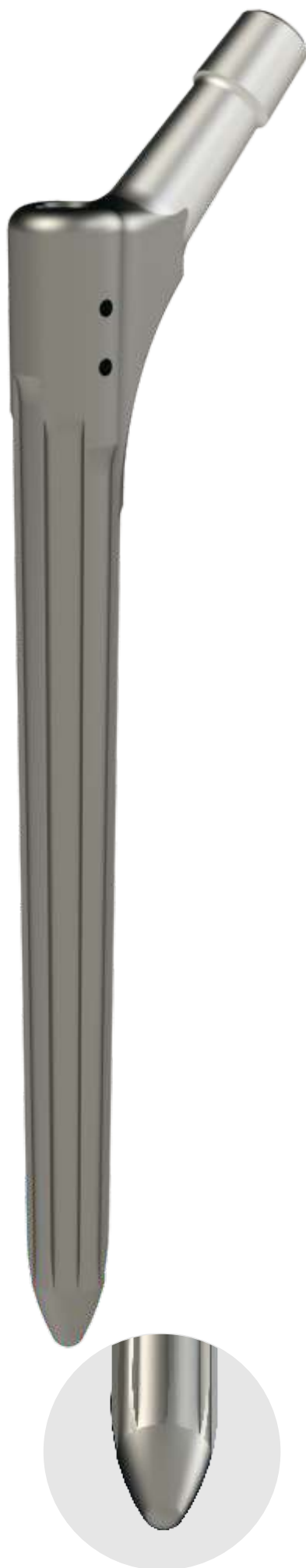

| RÉF. NON (TI) | TAILLE | RÉF. NON (TI) | TAILLE |
|---------------|--------|---------------|--------|
| R.7462-0010 | 10mm | R.7462-0014 | 14mm |
| R.7462-0011 | 11mm | R.7462-0015 | 15mm |
| R.7462-0012 | 12mm | R.7462-0016 | 16mm |
| R.7462-0013 | 13mm | | |

Cage acétabulaire

| RÉF. NON (TI) | TAILLE |
|---------------|--------|
| * R.7582-0044 | 44mm |
| * R.7582-0046 | 46mm |
| * R.7582-0048 | 48mm |
| R.7582-0050 | 50mm |
| * R.7582-0052 | 52mm |
| * R.7582-0054 | 54mm |
| R.7582-0056 | 56mm |
| * R.7582-0058 | 58mm |
| * R.7582-0060 | 60mm |
| R.7582-0062 | 62mm |



Cage acétabulaire

| RÉF. NON (TI) | TAILLE |
|---------------|--------|
| * R.7572-1044 | 44mm |
| * R.7572-1046 | 46mm |
| * R.7572-1048 | 48mm |
| R.7572-1050 | 50mm |
| * R.7572-1052 | 52mm |
| * R.7572-1054 | 54mm |
| R.7572-1056 | 56mm |
| * R.7572-1058 | 58mm |
| * R.7572-1060 | 60mm |
| R.7572-1062 | 62mm |

Court / Gauche

| RÉF. NON (TI) | TAILLE |
|---------------|--------|
| * R.7572-2044 | 44mm |
| * R.7572-2046 | 46mm |
| * R.7572-2048 | 48mm |
| R.7572-2050 | 50mm |
| * R.7572-2052 | 52mm |
| * R.7572-2054 | 54mm |
| R.7572-2056 | 56mm |
| * R.7572-2058 | 58mm |
| * R.7572-2060 | 60mm |
| R.7572-2062 | 62mm |

* Ces tailles sont produites en option



Systèmes d'arthroplastie

Prothèse totale de l'articulation du genou



Composant fémoral P/S



| RÉF. NON (Alliage CoCrMo) Molibden au chrome de cobalt | TAILLE |
|--|---------|
| 7513-1001 | 2/55-R |
| 7513-1002 | 4/60-R |
| 7513-1003 | 6/65-R |
| 7513-1004 | 8/70-R |
| 7513-1005 | 10/75-R |
| 7513-2001 | 2/55-L |
| 7513-2002 | 4/60-L |
| 7513-2003 | 6/65-L |
| 7513-2004 | 8/70-L |
| 7513-2005 | 10/75-L |

Composant du tibia



| RÉF. NON (Alliage CoCrMo) Molibden au chrome de cobalt | TAILLE |
|--|--------|
| 7693-0001 | 2/55 |
| 7693-0002 | 4/60 |
| 7693-0003 | 6/65 |
| 7693-0004 | 8/70 |
| 7693-0005 | 10/75 |

Composant fémoral C/R



| RÉF. NON (Alliage CoCrMo) Molibden au chrome de cobalt | TAILLE |
|--|---------|
| 7503-1001 | 2/55-R |
| 7503-1002 | 4/60-R |
| 7503-1003 | 6/65-R |
| 7503-1004 | 8/70-R |
| 7503-1005 | 10/75-R |
| 7503-2001 | 2/55-L |
| 7503-2002 | 4/60-L |
| 7503-2003 | 6/65-L |
| 7503-2004 | 8/70-L |
| 7503-2005 | 10/75-L |

Arthroplasty Systems

Prothèse totale de l'articulation du genou



Insertion tibiale (Hyperflex) P/S



| RÉF. NON (HYPERFLEX) (UHMWPE) (FIXED) | TAILLE (mm) |
|--|----------------|
| 7539-0101 | 2/9 |
| 7539-0102 | 2/11 |
| 7539-0103 | 2/13 |
| 7539-0104 | 2/15 |
| 7539-0105 | 2/17 |
| 7539-0201 | 4/9 |
| 7539-0202 | 4/11 |
| 7539-0203 | 4/13 |
| 7539-0204 | 4/15 |
| 7539-0205 | 4/17 |
| 7539-0301 | 6/9 |
| 7539-0302 | 6/11 |
| 7539-0303 | 6/13 |
| 7539-0304 | 6/15 |
| 7539-0305 | 6/17 |
| 7539-0401 | 8/9 |
| 7539-0402 | 8/11 |
| 7539-0403 | 8/13 |
| 7539-0404 | 8/15 |
| 7539-0405 | 8/17 |
| 7539-0501 | 10/9 |
| 7539-0502 | 10/11 |
| 7539-0503 | 10/13 |
| 7539-0504 | 10/15 |
| 7539-0505 | 10/17 |

Insertion tibiale (Hyperflex) C/R



| RÉF. NON (HYPERFLEX) (UHMWPE) (FIXED) | TAILLE (mm) |
|--|----------------|
| 7549-0101 | 2/9 |
| 7549-0102 | 2/11 |
| 7549-0103 | 2/13 |
| 7549-0104 | 2/15 |
| 7549-0105 | 2/17 |
| 7549-0201 | 4/9 |
| 7549-0202 | 4/11 |
| 7549-0203 | 4/13 |
| 7549-0204 | 4/15 |
| 7549-0205 | 4/17 |
| 7549-0301 | 6/9 |
| 7549-0302 | 6/11 |
| 7549-0303 | 6/13 |
| 7549-0304 | 6/15 |
| 7549-0305 | 6/17 |
| 7549-0401 | 8/9 |
| 7549-0402 | 8/11 |
| 7549-0403 | 8/13 |
| 7549-0404 | 8/15 |
| 7549-0405 | 8/17 |
| 7549-0501 | 10/9 |
| 7549-0502 | 10/11 |
| 7549-0503 | 10/13 |
| 7549-0504 | 10/15 |
| 7549-0505 | 10/17 |

Composant de la rotule



| RÉF. NON (UHMWPE) | TAILLE (mm) |
|----------------------|----------------|
| 7849-0002 | 26 |
| 7849-0003 | 29 |
| 7849-0004 | 32 |
| 7849-0005 | 35 |





VISION-R GENOU

Systèmes d'arthroplastie

Genou Vision-R

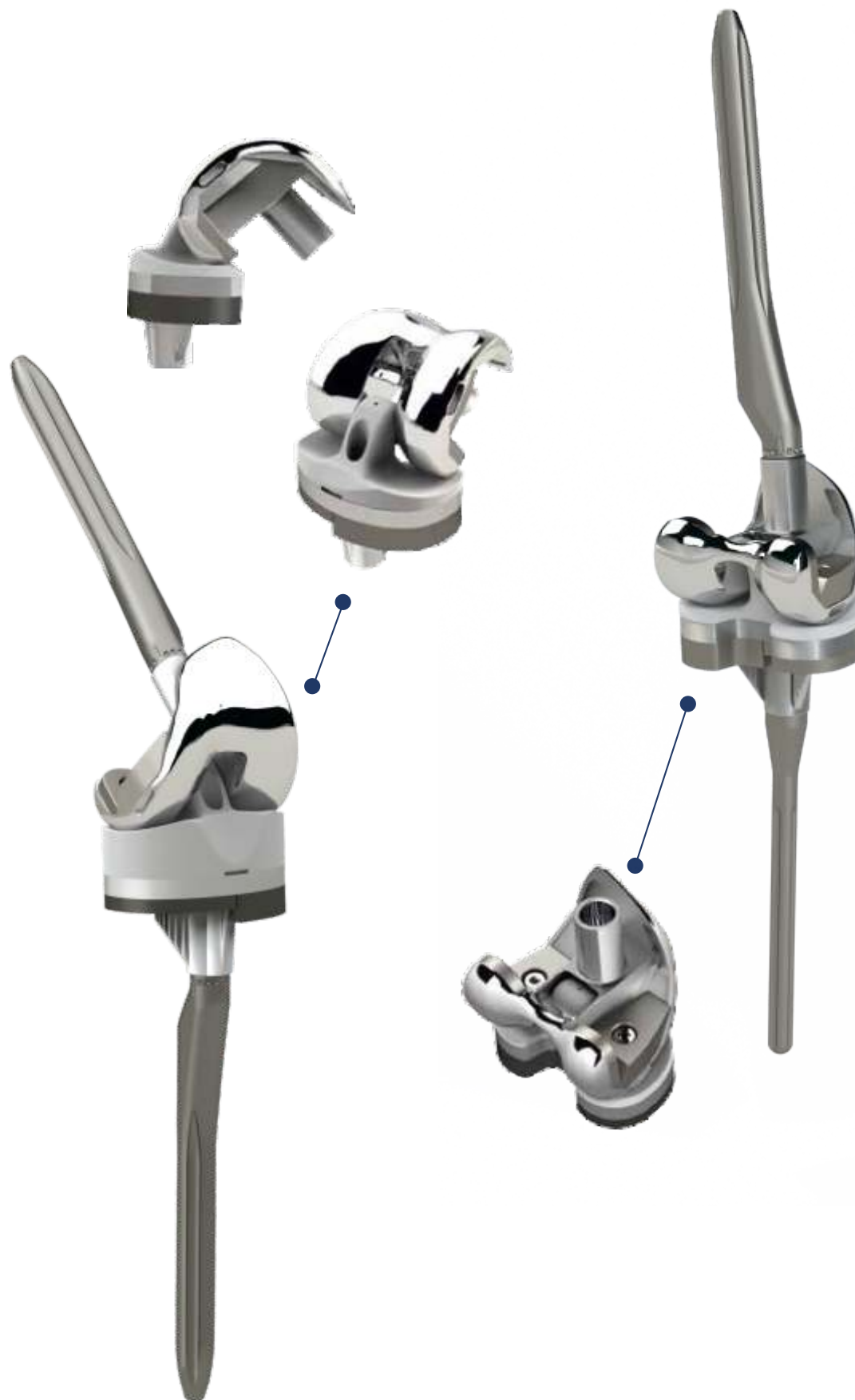



Systemes d'arthroplastie

Genou Vision-R

Prothese de revision du genou à tige droite

| RÉF. NO | TAILLE |
|-------------|--------|
| R.7042-0906 | 9-60 |
| R.7042-0910 | 9-100 |
| R.7042-0913 | 9-130 |
| R.7042-1006 | 10-60 |
| R.7042-1010 | 10-100 |
| R.7042-1013 | 10-130 |
| R.7042-1106 | 11-60 |
| R.7042-1110 | 11-100 |
| R.7042-1113 | 11-130 |
| R.7042-1206 | 12-60 |
| R.7042-1210 | 12-100 |
| R.7042-1213 | 12-130 |
| R.7042-1306 | 13-60 |
| R.7042-1310 | 13-100 |
| R.7042-1313 | 13-130 |
| R.7042-1406 | 14-60 |
| R.7042-1410 | 14-100 |
| R.7042-1413 | 14-130 |
| R.7042-1506 | 15-60 |
| R.7042-1510 | 15-100 |
| R.7042-1513 | 15-130 |
| R.7042-1606 | 16-60 |
| R.7042-1610 | 16-100 |
| R.7042-1613 | 16-130 |



Révision de la tige décalée de la prothese du genou

| RÉF. NO | TAILLE |
|-------------|--------|
| R.7052-0906 | 9-60 |
| R.7052-0910 | 9-100 |
| R.7052-0913 | 9-130 |
| R.7052-1006 | 10-60 |
| R.7052-1010 | 10-100 |
| R.7052-1013 | 10-130 |
| R.7052-1106 | 11-60 |
| R.7052-1110 | 11-100 |
| R.7052-1113 | 11-130 |
| R.7052-1206 | 12-60 |
| R.7052-1210 | 12-100 |
| R.7052-1213 | 12-130 |
| R.7052-1306 | 13-60 |
| R.7052-1310 | 13-100 |
| R.7052-1313 | 13-130 |
| R.7052-1406 | 14-60 |
| R.7052-1410 | 14-100 |
| R.7052-1413 | 14-130 |
| R.7052-1506 | 15-60 |
| R.7052-1510 | 15-100 |
| R.7052-1513 | 15-130 |
| R.7052-1606 | 16-60 |
| R.7052-1610 | 16-100 |
| R.7052-1613 | 16-130 |



Systemes d'arthroplastie

Genou Vision-R



Révision de prothèse de genou Tibia Plato



| RÉF. NO | TAILLE |
|-------------|---------|
| R.7013-0002 | 2 - (A) |
| R.7013-0003 | 3 - (A) |
| R.7013-0004 | 4 - (B) |
| R.7013-0005 | 5 - (B) |
| R.7013-0006 | 6 - (C) |
| R.7013-0007 | 7 - (C) |

Composant fémoral de la prothèse de genou de révision



| REF. NO (CoCrMo Alloy) | SIZE |
|---------------------------|---------|
| R.7023-1002 | 2-R (A) |
| R.7023-1003 | 3-R (A) |
| R.7023-1004 | 4-R (B) |
| R.7023-1005 | 5-R (B) |
| R.7023-1006 | 6-R (C) |
| R.7023-1007 | 7-R (C) |
| R.7023-2002 | 2-L (A) |
| R.7023-2003 | 3-L (A) |
| R.7023-2004 | 4-L (B) |
| R.7023-2005 | 5-L (B) |
| R.7023-2006 | 6-L (C) |
| R.7023-2007 | 7-L (C) |

Insert de tibia pour prothèse de genou de révision



| RÉF. NO (HYPERFLEX) (UHMWPE) (FIXED) | TAILLE |
|---|--------|
| R.7039-0009 | A-9 |
| R.7039-0011 | A-11 |
| R.7039-0013 | A-13 |
| R.7039-0015 | A-15 |
| R.7039-0017 | A-17 |
| R.7039-0019 | A-19 |
| R.7039-0021 | A-21 |
| R.7039-1009 | B-9 |
| R.7039-1011 | B-11 |
| R.7039-1013 | B-13 |
| R.7039-1015 | B-15 |
| R.7039-1017 | B-17 |
| R.7039-1019 | B-19 |
| R.7039-1021 | B-21 |
| R.7039-2009 | C-9 |
| R.7039-2011 | C-11 |
| R.7039-2013 | C-13 |
| R.7039-2015 | C-15 |
| R.7039-2017 | C-17 |
| R.7039-2019 | C-19 |
| R.7039-2021 | C-21 |

Vis d'insertion pour prothèse de genou de révision



| REF. NO | SIZE (mm) |
|-------------|--------------|
| R.7122-0533 | 5x33 |



Systèmes d'arthroplastie

Genou Vision-R



Révision de la prothèse du genou du tibia Plato Half Wedge



| RÉF. NO | TAILLE |
|-------------|--------|
| R.7082-0502 | 5 / 2 |
| R.7082-1002 | 10 / 2 |
| R.7082-0503 | 5 / 3 |
| R.7082-1003 | 10 / 3 |
| R.7082-0504 | 5 / 4 |
| R.7082-1004 | 10 / 4 |
| R.7082-0505 | 5 / 5 |
| R.7082-1005 | 10 / 5 |
| R.7082-0506 | 5 / 6 |
| R.7082-1006 | 10 / 6 |
| R.7082-0507 | 5 / 7 |
| R.7082-1007 | 10 / 7 |

Révision de la prothèse du genou du fémur Cale postérieure



| RÉF. NO | TAILLE |
|-------------|--------|
| R.7072-0502 | 5 / 2 |
| R.7072-1002 | 10 / 2 |
| R.7072-0503 | 5 / 3 |
| R.7072-1003 | 10 / 3 |
| R.7072-0504 | 5 / 4 |
| R.7072-1004 | 10 / 4 |
| R.7072-0505 | 5 / 5 |
| R.7072-1005 | 10 / 5 |
| R.7072-0506 | 5 / 6 |
| R.7072-1006 | 10 / 6 |
| R.7072-0507 | 5 / 7 |
| R.7072-1007 | 10 / 7 |

Révision de la prothèse du genou du fémur Cale distale



| RÉF. NO | TAILLE |
|-------------|--------|
| R.7062-0502 | 5 / 2 |
| R.7062-1002 | 10 / 2 |
| R.7062-0503 | 5 / 3 |
| R.7062-1003 | 10 / 3 |
| R.7062-0504 | 5 / 4 |
| R.7062-1004 | 10 / 4 |
| R.7062-0505 | 5 / 5 |
| R.7062-1005 | 10 / 5 |
| R.7062-0506 | 5 / 6 |
| R.7062-1006 | 10 / 6 |
| R.7062-0507 | 5 / 7 |
| R.7062-1007 | 10 / 7 |

Révision de la prothèse du genou avec vis à coin tibial



| RÉF. NO | TAILLE (mm) |
|-------------|----------------|
| R.7122-0505 | 5x5 |
| R.7122-0506 | 5x6 |







Systèmes de plaques



Systèmes d'arthroplastie



Systèmes de clous⁺

| | |
|---|----|
| Systèmes d'ongles PFNA | 47 |
| Systèmes de clous fémoraux multi-usages ZFN | 49 |
| Systèmes de clous pour arthrodèse fémur-tibia | 50 |
| Clou fémoral rétrograde | 51 |
| Systèmes de clous tibiaux ZTN | 52 |
| Clou huméral intramédullaire canulé | 53 |
| Clou élastique en titane | 54 |



Systèmes de fixation externes

Broches et fils squelettiques

Systèmes spinaux

Arthroscopie

SYSTEMS



Clous intramédullaires

Systèmes d'ongles PFNA



Clou fémoral proximal antirotation Simplelock / Interclaw

| COURT | | LONGUE | | DROITE | | LONGUE | | GAUCHE | |
|-----------|-------------|-----------|-------------|-----------|-------------|---------|-------------|---------|-------------|
| RÉF. NO | TAILLE (mm) | RÉF. NO | TAILLE (mm) | RÉF. NO | TAILLE (mm) | RÉF. NO | TAILLE (mm) | RÉF. NO | TAILLE (mm) |
| 4552-1017 | 10x170 | 4752-1034 | 10x340 | 4762-1034 | 10x340 | | | | |
| 4552-1020 | 10x200 | 4752-1036 | 10x360 | 4762-1036 | 10x360 | | | | |
| 4552-1024 | 10x240 | 4752-1038 | 10x380 | 4762-1038 | 10x380 | | | | |
| 4552-1117 | 11x170 | 4752-1134 | 11x340 | 4762-1134 | 11x340 | | | | |
| 4552-1120 | 11x200 | 4752-1136 | 11x360 | 4762-1136 | 11x360 | | | | |
| 4552-1124 | 11x240 | 4752-1138 | 11x380 | 4762-1138 | 11x380 | | | | |
| 4552-1217 | 12x170 | 4752-1234 | 12x340 | 4762-1234 | 12x340 | | | | |
| 4552-1220 | 12x200 | 4752-1236 | 12x360 | 4762-1236 | 12x360 | | | | |
| 4552-1224 | 12x240 | 4752-1238 | 12x380 | 4762-1238 | 12x380 | | | | |
| 4552-1317 | 13x170 | 4752-1334 | 13x340 | 4762-1334 | 13x340 | | | | |
| 4552-1320 | 13x200 | 4752-1336 | 13x360 | 4762-1336 | 13x360 | | | | |
| 4552-1324 | 13x240 | 4752-1338 | 13x380 | 4762-1338 | 13x380 | | | | |
| 4552-1417 | 14x170 | | | | | | | | |
| 4552-1420 | 14x200 | | | | | | | | |
| 4552-1424 | 14x240 | | | | | | | | |

Vis à tête creuse

| RÉF. NO | TAILLE (mm) |
|-----------|-------------|
| 4582-0080 | 80 |
| 4582-0085 | 85 |
| 4582-0090 | 90 |
| 4582-0095 | 95 |
| 4582-0100 | 100 |
| 4582-0105 | 105 |
| 4582-0110 | 110 |
| 4582-0115 | 115 |
| 4582-0120 | 120 |



Vis de verrouillage distale PFNA (Gamma)(Ø 4.8 mm)

| RÉF. NO | TAILLE (mm) |
|-----------|-------------|
| 4992-4830 | 30 |
| 4992-4835 | 35 |
| 4992-4840 | 40 |
| 4992-4845 | 45 |
| 4992-4850 | 50 |
| 4992-4855 | 55 |
| 4992-4860 | 60 |
| 4992-4865 | 65 |
| 4992-4870 | 70 |
| 4992-4875 | 75 |
| 4992-4880 | 80 |
| 4992-4885 | 85 |
| 4992-4890 | 90 |



Embout PFNA

| RÉF. NO | TAILLE (mm) |
|-----------|-------------|
| 4562-0000 | 0 |
| 4562-0005 | 5 |
| 4562-0010 | 10 |



Clous intramédullaires

Systemes d'ongles PFNA



Vis tire-fond Simplelock Entegre

| RÉF. NO | TAILLE (mm) |
|-----------|-------------|
| 4782-0065 | 65 |
| 4782-0070 | 70 |
| 4782-0075 | 75 |
| 4782-0080 | 80 |
| 4782-0085 | 85 |
| 4782-0090 | 90 |
| 4782-0095 | 95 |
| 4782-0100 | 100 |
| 4782-0105 | 105 |
| 4782-0110 | 110 |
| 4782-0115 | 115 |
| 4782-0120 | 120 |



Vis de compression anti-rotation Simplelock Entegre

| RÉF. NO | TAILLE (mm) |
|-----------|-------------|
| 4792-0060 | 60 |
| 4792-0065 | 65 |
| 4792-0070 | 70 |
| 4792-0075 | 75 |
| 4792-0080 | 80 |
| 4792-0085 | 85 |
| 4792-0090 | 90 |
| 4792-0095 | 95 |
| 4792-0100 | 100 |
| 4792-0105 | 105 |
| 4792-0110 | 110 |
| 4792-0115 | 115 |



Vis LAG Interclaw

| RÉF. NO | TAILLE (mm) |
|-----------|-------------|
| 4642-0080 | 80 |
| 4642-0085 | 85 |
| 4642-0090 | 90 |
| 4642-0095 | 95 |
| 4642-0100 | 100 |
| 4642-0105 | 105 |
| 4642-0110 | 110 |
| 4642-0115 | 115 |
| 4642-0120 | 120 |



Lame LAG Interclaw

| RÉF. NO | TAILLE (mm) |
|-----------|-------------|
| 4592-0080 | 80 |
| 4592-0085 | 85 |
| 4592-0090 | 90 |
| 4592-0095 | 95 |
| 4592-0100 | 100 |
| 4592-0105 | 105 |
| 4592-0110 | 110 |
| 4592-0115 | 115 |
| 4592-0120 | 120 |



Embout Interclaw



| RÉF. NO | TAILLE (mm) |
|-----------|-------------|
| 4072-0000 | 50 |
| 4072-0001 | 55 |

Vis de blocage LAG



| RÉF. NO (CoCrMo Alloy) |
|------------------------|
| 4573-0000 |





Clous intramédullaires

Systèmes de clous fémoraux multi-usages ZFN

Systèmes de clous fémoraux multi-usages ZFN

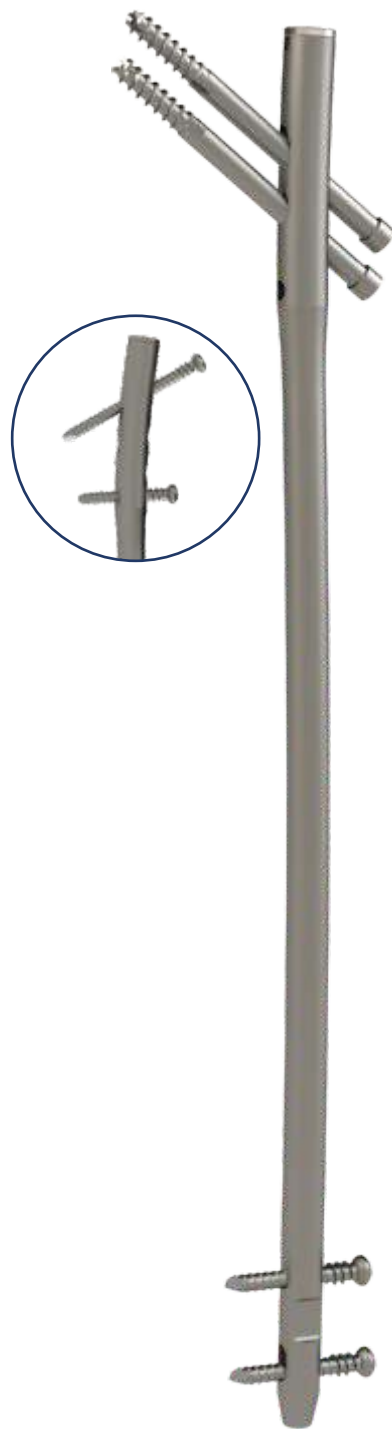

| COURT | | LONGUE | | DROITE | | LONGUE | | GAUCHE | |
|-----------|-------------|-----------|-------------|-----------|-------------|-----------|-------------|-----------|-------------|
| RÉF. NO | TAILLE (mm) | RÉF. NO | TAILLE (mm) | RÉF. NO | TAILLE (mm) | RÉF. NO | TAILLE (mm) | RÉF. NO | TAILLE (mm) |
| 4602-0918 | 9x180 | 4262-0932 | 9x320 | 4272-0932 | 9x320 | 4272-0932 | 9x320 | 4272-0932 | 9x320 |
| 4602-0920 | 9x200 | 4262-0934 | 9x340 | 4272-0934 | 9x340 | 4272-0934 | 9x340 | 4272-0934 | 9x340 |
| 4602-0922 | 9x220 | 4262-0936 | 9x360 | 4272-0936 | 9x360 | 4272-0936 | 9x360 | 4272-0936 | 9x360 |
| 4602-0924 | 9x240 | 4262-0938 | 9x380 | 4272-0938 | 9x380 | 4272-0938 | 9x380 | 4272-0938 | 9x380 |
| 4602-1018 | 10x180 | 4262-0940 | 9x400 | 4272-0940 | 9x400 | 4272-0940 | 9x400 | 4272-0940 | 9x400 |
| 4602-1020 | 10x200 | 4262-0942 | 9x420 | 4272-0942 | 9x420 | 4272-0942 | 9x420 | 4272-0942 | 9x420 |
| 4602-1022 | 10x220 | 4262-0944 | 9x440 | 4272-0944 | 9x440 | 4272-0944 | 9x440 | 4272-0944 | 9x440 |
| 4602-1024 | 10x240 | 4262-1032 | 10x 320 | 4272-1032 | 10x 320 | 4272-1032 | 10x 320 | 4272-1032 | 10x 320 |
| 4602-1118 | 11x180 | 4262-1034 | 10x 340 | 4272-1034 | 10x 340 | 4272-1034 | 10x 340 | 4272-1034 | 10x 340 |
| 4602-1120 | 11x200 | 4262-1036 | 10x 360 | 4272-1036 | 10x 360 | 4272-1036 | 10x 360 | 4272-1036 | 10x 360 |
| 4602-1122 | 11x220 | 4262-1038 | 10x 380 | 4272-1038 | 10x 380 | 4272-1038 | 10x 380 | 4272-1038 | 10x 380 |
| 4602-1124 | 11x240 | 4262-1040 | 10x 400 | 4272-1040 | 10x 400 | 4272-1040 | 10x 400 | 4272-1040 | 10x 400 |
| 4602-1218 | 12x180 | 4262-1042 | 10x 420 | 4272-1042 | 10x 420 | 4272-1042 | 10x 420 | 4272-1042 | 10x 420 |
| 4602-1220 | 12x200 | 4262-1044 | 10x 440 | 4272-1044 | 10x 440 | 4272-1044 | 10x 440 | 4272-1044 | 10x 440 |
| 4602-1222 | 12x220 | 4262-1132 | 11x 320 | 4272-1132 | 11x 320 | 4272-1132 | 11x 320 | 4272-1132 | 11x 320 |
| 4602-1224 | 12x240 | 4262-1134 | 11x 340 | 4272-1134 | 11x 340 | 4272-1134 | 11x 340 | 4272-1134 | 11x 340 |
| 4602-1318 | 13x180 | 4262-1136 | 11x 360 | 4272-1136 | 11x 360 | 4272-1136 | 11x 360 | 4272-1136 | 11x 360 |
| 4602-1320 | 13x200 | 4262-1138 | 11x 380 | 4272-1138 | 11x 380 | 4272-1138 | 11x 380 | 4272-1138 | 11x 380 |
| 4602-1322 | 13x220 | 4262-1140 | 11x 400 | 4272-1140 | 11x 400 | 4272-1140 | 11x 400 | 4272-1140 | 11x 400 |
| 4602-1324 | 13x240 | 4262-1142 | 11x 420 | 4272-1142 | 11x 420 | 4272-1142 | 11x 420 | 4272-1142 | 11x 420 |
| 4602-1418 | 14x180 | 4262-1144 | 11x 440 | 4272-1144 | 11x 440 | 4272-1144 | 11x 440 | 4272-1144 | 11x 440 |
| 4602-1420 | 14x200 | 4262-1232 | 12x 320 | 4272-1232 | 12x 320 | 4272-1232 | 12x 320 | 4272-1232 | 12x 320 |
| 4602-1422 | 14x220 | 4262-1234 | 12x 340 | 4272-1234 | 12x 340 | 4272-1234 | 12x 340 | 4272-1234 | 12x 340 |
| 4602-1424 | 14x240 | 4262-1236 | 12x 360 | 4272-1236 | 12x 360 | 4272-1236 | 12x 360 | 4272-1236 | 12x 360 |
| | | 4262-1238 | 12x 380 | 4272-1238 | 12x 380 | 4272-1238 | 12x 380 | 4272-1238 | 12x 380 |
| | | 4262-1240 | 12x 400 | 4272-1240 | 12x 400 | 4272-1240 | 12x 400 | 4272-1240 | 12x 400 |
| | | 4262-1242 | 12x 420 | 4272-1242 | 12x 420 | 4272-1242 | 12x 420 | 4272-1242 | 12x 420 |
| | | 4262-1244 | 12x 440 | 4272-1244 | 12x 440 | 4272-1244 | 12x 440 | 4272-1244 | 12x 440 |
| | | 4262-1332 | 13x 320 | 4272-1332 | 13x 320 | 4272-1332 | 13x 320 | 4272-1332 | 13x 320 |
| | | 4262-1334 | 13x 340 | 4272-1334 | 13x 340 | 4272-1334 | 13x 340 | 4272-1334 | 13x 340 |
| | | 4262-1336 | 13x 360 | 4272-1336 | 13x 360 | 4272-1336 | 13x 360 | 4272-1336 | 13x 360 |
| | | 4262-1338 | 13x 380 | 4272-1338 | 13x 380 | 4272-1338 | 13x 380 | 4272-1338 | 13x 380 |
| | | 4262-1340 | 13x 400 | 4272-1340 | 13x 400 | 4272-1340 | 13x 400 | 4272-1340 | 13x 400 |
| | | 4262-1342 | 13x 420 | 4272-1342 | 13x 420 | 4272-1342 | 13x 420 | 4272-1342 | 13x 420 |
| | | 4262-1344 | 13x 440 | 4272-1344 | 13x 440 | 4272-1344 | 13x 440 | 4272-1344 | 13x 440 |
| | | 4262-1432 | 14x 320 | 4272-1432 | 14x 320 | 4272-1432 | 14x 320 | 4272-1432 | 14x 320 |
| | | 4262-1434 | 14x 340 | 4272-1434 | 14x 340 | 4272-1434 | 14x 340 | 4272-1434 | 14x 340 |
| | | 4262-1436 | 14x 360 | 4272-1436 | 14x 360 | 4272-1436 | 14x 360 | 4272-1436 | 14x 360 |
| | | 4262-1438 | 14x 380 | 4272-1438 | 14x 380 | 4272-1438 | 14x 380 | 4272-1438 | 14x 380 |
| | | 4262-1440 | 14x 400 | 4272-1440 | 14x 400 | 4272-1440 | 14x 400 | 4272-1440 | 14x 400 |
| | | 4262-1442 | 14x 420 | 4272-1442 | 14x 420 | 4272-1442 | 14x 420 | 4272-1442 | 14x 420 |
| | | 4262-1444 | 14x 440 | 4272-1444 | 14x 440 | 4272-1444 | 14x 440 | 4272-1444 | 14x 440 |

Clous intramédullaires

Systèmes de clous pour arthrodèse fémur-tibia



Vis de verrouillage proximale/distale
(Ø 4.8 mm)



| RÉF. NO | TAILLE (mm) |
|-----------|-------------|
| 4292-4830 | 30 |
| 4292-4835 | 35 |
| 4292-4840 | 40 |
| 4292-4845 | 45 |
| 4292-4850 | 50 |
| 4292-4855 | 55 |
| 4292-4860 | 60 |
| 4292-4865 | 65 |
| 4292-4870 | 70 |
| 4292-4875 | 75 |
| 4292-4880 | 80 |
| 4292-4885 | 85 |
| 4292-4890 | 90 |

Clou d'arthrodèse fémur-tibia (sur mesure)



Clou d'arthrodèse fémur-tibia (sur mesure)
(Ø 6.4 mm)



| RÉF. NO | TAILLE (mm) |
|-----------|-------------|
| 4612-6050 | 50 |
| 4612-6055 | 55 |
| 4612-6060 | 60 |
| 4612-6065 | 65 |
| 4612-6070 | 70 |
| 4612-6075 | 75 |
| 4612-6080 | 80 |
| 4612-6085 | 85 |
| 4612-6090 | 90 |
| 4612-6095 | 95 |
| 4612-6100 | 100 |
| 4612-6105 | 105 |
| 4612-6110 | 110 |
| 4612-6115 | 115 |
| 4612-6120 | 120 |

Vis de fixation proximale pour ZFN



| RÉF. NO |
|-----------|
| 4622-0000 |

Embout



| RÉF. NO | TAILLE (mm) |
|-----------|-------------|
| 4602-0000 | 0 |
| 4602-0005 | 5 |
| 4602-0010 | 10 |

| RÉF. NO |
|-----------|
| 4052-0000 |





Clous intramédullaires

Clou fémoral rétrograde intramédullaire canulé

| RÉF. NO | TAILLE |
|-----------|--------|
| 4122-0918 | 9x180 |
| 4122-0920 | 9x200 |
| 4122-0922 | 9x220 |
| 4122-0924 | 9x240 |
| 4122-0926 | 9x260 |
| 4122-0928 | 9x280 |
| 4122-0930 | 9x300 |
| 4122-0932 | 9x320 |
| 4122-0934 | 9x340 |
| 4122-0936 | 9x360 |
| 4122-1018 | 10x180 |
| 4122-1020 | 10x200 |
| 4122-1022 | 10x220 |
| 4122-1024 | 10x240 |
| 4122-1026 | 10x260 |
| 4122-1028 | 10x280 |
| 4122-1030 | 10x300 |
| 4122-1032 | 10x320 |
| 4122-1034 | 10x340 |
| 4122-1036 | 10x360 |
| 4122-1118 | 11x180 |
| 4122-1120 | 11x200 |
| 4122-1122 | 11x220 |
| 4122-1124 | 11x240 |
| 4122-1126 | 11x260 |
| 4122-1128 | 11x280 |
| 4122-1130 | 11x300 |
| 4122-1132 | 11x320 |
| 4122-1134 | 11x340 |
| 4122-1136 | 11x360 |
| 4122-1218 | 12x180 |
| 4122-1220 | 12x200 |
| 4122-1222 | 12x220 |
| 4122-1224 | 12x240 |
| 4122-1226 | 12x260 |
| 4122-1228 | 12x280 |
| 4122-1230 | 12x300 |
| 4122-1232 | 12x320 |
| 4122-1234 | 12x340 |
| 4122-1236 | 12x360 |
| 4122-1318 | 13x180 |
| 4122-1320 | 13x200 |
| 4122-1322 | 13x220 |
| 4122-1324 | 13x240 |
| 4122-1326 | 13x260 |
| 4122-1328 | 13x280 |
| 4122-1330 | 13x300 |
| 4122-1332 | 13x320 |

Clou fémoral rétrograde intramédullaire canulé



Vis de verrouillage proximale (Ø 4.8 mm)

| RÉF. NO | LONGUEUR (mm) |
|-----------|---------------|
| 4282-4830 | 30 |
| 4282-4835 | 35 |
| 4282-4840 | 40 |
| 4282-4845 | 45 |
| 4282-4850 | 50 |
| 4282-4855 | 55 |
| 4282-4860 | 60 |
| 4282-4865 | 65 |
| 4282-4870 | 70 |
| 4282-4875 | 75 |
| 4282-4880 | 80 |
| 4282-4885 | 85 |
| 4282-4890 | 90 |



Vis de verrouillage distale (Ø 4.35 mm)

| RÉF. NO | LONGUEUR (mm) |
|-----------|---------------|
| 4282-4330 | 30 |
| 4282-4335 | 35 |
| 4282-4340 | 40 |
| 4282-4345 | 45 |
| 4282-4350 | 50 |
| 4282-4355 | 55 |
| 4282-4360 | 60 |
| 4282-4365 | 65 |
| 4282-4370 | 70 |
| 4282-4375 | 75 |
| 4282-4380 | 80 |
| 4282-4385 | 85 |
| 4282-4390 | 90 |



Embout de clou fémoral rétrograde



| RÉF. NO | LONGUEUR (mm) |
|-----------|---------------|
| 4122-0000 | 0 |
| 4122-0005 | 5 |
| 4122-0010 | 10 |

Clous intramédullaires

Systèmes de clous tibiaux ZTN



Systèmes de clous tibiaux ZTN

| RÉF. NO | TAILLE (mm) |
|-----------|-------------|
| 4252-0825 | 8x255 |
| 4252-0827 | 8x270 |
| 4252-0828 | 8x285 |
| 4252-0830 | 8x300 |
| 4252-0831 | 8x315 |
| 4252-0833 | 8x330 |
| 4252-0834 | 8x345 |
| 4252-0836 | 8x360 |
| 4252-0837 | 8x375 |
| 4252-0925 | 9x255 |
| 4252-0927 | 9x270 |
| 4252-0928 | 9x285 |
| 4252-0930 | 9x300 |
| 4252-0931 | 9x315 |
| 4252-0933 | 9x330 |
| 4252-0934 | 9x345 |
| 4252-0936 | 9x360 |
| 4252-0937 | 9x375 |
| 4252-1025 | 10x 255 |
| 4252-1027 | 10x 270 |
| 4252-1028 | 10x 285 |
| 4252-1030 | 10x 300 |
| 4252-1031 | 10x 315 |
| 4252-1033 | 10x 330 |
| 4252-1034 | 10x 345 |
| 4252-1036 | 10x 360 |
| 4252-1037 | 10x 375 |
| 4252-1125 | 11x 255 |
| 4252-1127 | 11x 270 |
| 4252-1128 | 11x 285 |
| 4252-1130 | 11x 300 |
| 4252-1131 | 11x 315 |
| 4252-1133 | 11x 330 |
| 4252-1134 | 11x 345 |
| 4252-1136 | 11x 360 |
| 4252-1137 | 11x 375 |

| RÉF. NO | TAILLE (mm) |
|-----------|-------------|
| 4252-1225 | 12x 255 |
| 4252-1227 | 12x 270 |
| 4252-1228 | 12x 285 |
| 4252-1230 | 12x 300 |
| 4252-1231 | 12x 315 |
| 4252-1233 | 12x 330 |
| 4252-1234 | 12x 345 |
| 4252-1236 | 12x 360 |
| 4252-1237 | 12x 375 |
| 4252-1325 | 13x 255 |
| 4252-1327 | 13x 270 |
| 4252-1328 | 13x 285 |
| 4252-1330 | 13x 300 |
| 4252-1331 | 13x 315 |
| 4252-1333 | 13x 330 |
| 4252-1334 | 13x 345 |
| 4252-1336 | 13x 360 |
| 4252-1337 | 13x 375 |
| 4252-1425 | 14x 255 |
| 4252-1427 | 14x 270 |
| 4252-1428 | 14x 285 |
| 4252-1430 | 14x 300 |
| 4252-1431 | 14x 315 |
| 4252-1433 | 14x 330 |
| 4252-1434 | 14x 345 |
| 4252-1436 | 14x 360 |
| 4252-1437 | 14x 375 |

Embout ZTN



| RÉF. NO | TAILLE (mm) |
|-----------|-------------|
| 4252-0000 | 0 |
| 4252-0005 | 5 |
| 4252-0010 | 10 |



Clous intramédullaires

Clou huméral intramédullaire canulé

Clou huméral intramédullaire canulé



| RÉF. NO | TAILLE (mm) |
|-----------|-------------|
| 4102-0716 | 7x160 |
| 4102-0718 | 7x180 |
| 4102-0720 | 7x200 |
| 4102-0722 | 7x220 |
| 4102-0724 | 7x240 |
| 4102-0726 | 7x260 |
| 4102-0728 | 7x280 |
| 4102-0816 | 8x160 |
| 4102-0818 | 8x180 |
| 4102-0820 | 8x200 |
| 4102-0822 | 8x220 |
| 4102-0824 | 8x240 |
| 4102-0826 | 8x260 |
| 4102-0828 | 8x280 |
| 4102-0916 | 9x160 |
| 4102-0918 | 9x180 |
| 4102-0920 | 9x200 |
| 4102-0922 | 9x220 |
| 4102-0924 | 9x240 |
| 4102-0926 | 9x260 |
| 4102-0928 | 9x280 |

Vis de blocage pour clous (Ø 3.5 mm)



| RÉF. NO | TAILLE (mm) |
|-----------|-------------|
| 4042-0018 | 18 |
| 4042-0020 | 20 |
| 4042-0022 | 22 |
| 4042-0024 | 24 |
| 4042-0025 | 25 |
| 4042-0026 | 26 |
| 4042-0028 | 28 |
| 4042-0030 | 30 |
| 4042-0032 | 32 |
| 4042-0034 | 34 |
| 4042-0035 | 35 |
| 4042-0036 | 36 |
| 4042-0038 | 38 |
| 4042-0040 | 40 |
| 4042-0042 | 42 |
| 4042-0044 | 44 |
| 4042-0045 | 45 |
| 4042-0046 | 46 |
| 4042-0048 | 48 |
| 4042-0050 | 50 |

Embout de clou huméral



| RÉF. NO | TAILLE (mm) |
|-----------|-------------|
| 4112-0000 | 0 |

Clous intramédullaires

Clou élastique en titane

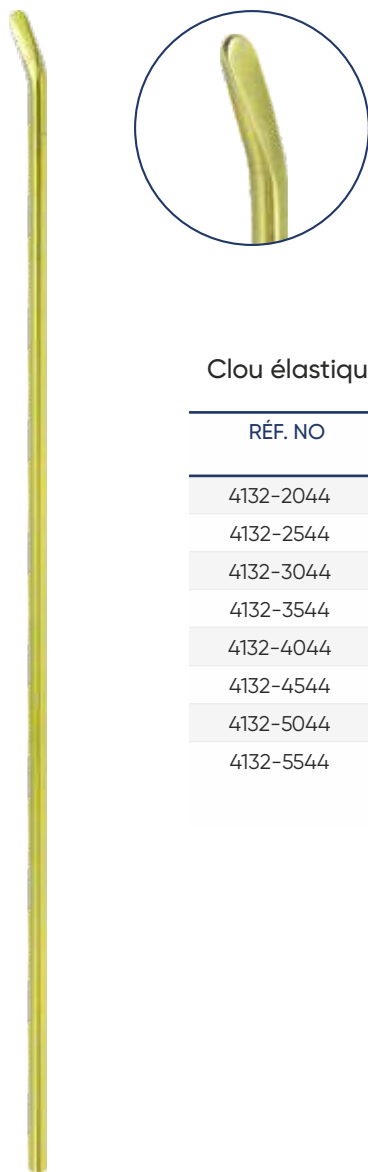

Clou élastique en titane

| RÉF. NO | TAILLE (mm) |
|-----------|-------------|
| 4132-2044 | 2.0x440 |
| 4132-2544 | 2.5X 440 |
| 4132-3044 | 3.0x440 |
| 4132-3544 | 3.5X440 |
| 4132-4044 | 4.0x440 |
| 4132-4544 | 4.5X440 |
| 4132-5044 | 5.0x440 |
| 4132-5544 | 5.5x440 |

Embout de clou élastique en titane

| RÉF. NO | TAILLE (mm) |
|-----------|-------------|
| 4132-0020 | 2mm |
| 4132-0025 | 2.5mm |
| 4132-0030 | 3mm |
| 4132-0035 | 3.5mm |
| 4132-0040 | 4mm |
| 4132-0045 | 4.5mm |
| 4132-0050 | 5mm |
| 4132-0055 | 5.5mm |







Systèmes de plaques



Systèmes d'arthroplastie



Systèmes de clous

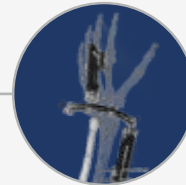

**Systèmes de fixation⁺
externes**

| | |
|--|----|
| External Fixators | 57 |
| Fixateurs externes hybrides | 60 |
| Petit ensemble de fixateurs tubulaires externes | 61 |
| Ensemble de grands fixateurs tubulaires externes | 62 |

Broches et fils squelettiques

Systèmes spinaux

Arthroscopie

FIXATEURS



Systèmes de fixation externes

Fixateurs externes

Fixateur de coude pour extrémités



Fixateur externe de type Penning



| RÉF. NO | TAILLE |
|-----------|--------|
| 5034-0001 | S |
| 5034-0002 | M |
| 5034-0003 | L |

Fixateur d'humérus segmentaire



| RÉF. NO | TAILLE |
|-----------|--------|
| 5164-0001 | S |
| 5164-0002 | M |
| 5164-0003 | L |

Fixateur de doigt (articulation)



| RÉF. NO |
|-----------|
| 5084-0000 |

Fixateur externe axial dynamique (humérus)



| RÉF. NO | TAILLE |
|-----------|--------|
| 5024-0001 | S |
| 5024-0002 | M |
| 5024-0003 | L |

Fixateur de doigt dynamique



| RÉF. NO |
|-----------|
| 5084-0002 |

Pince en T pour humérus



Allongeur Fixateur de Doigt



| RÉF. NO | TAILLE |
|-----------|--------|
| 5084-0010 | S |
| 5084-0020 | M |
| 5084-0030 | L |

Systemes de fixation externes

Fixateurs externes



Fixateurs Segmentel



| RÉF. NO | TAILLE |
|-----------|--------|
| 5074-0001 | S |
| 5074-0002 | M |
| 5074-0003 | L |

Fixateur externe axial dynamique (pelvien)



| RÉF. NO |
|-----------|
| 5044-0000 |

Fixateur externe axial dynamique (pelvien)



| RÉF. NO | TAILLE |
|-----------|--------|
| 5054-0001 | S |
| 5054-0002 | M |
| 5054-0003 | L |

Fixateur externe axial dynamique (pelvien)



| RÉF. NO | TAILLE |
|-----------|--------|
| 5044-0001 | S |
| 5044-0002 | M |
| 5044-0003 | L |

Fixateur Externe Axial Dynamique (Fémur - Tibia)



| RÉF. NO | TAILLE |
|-----------|--------|
| 5014-0001 | S |
| 5014-0002 | M |
| 5014-0003 | L |

Fixateurs de pylônes



| RÉF. NO | TAILLE |
|-----------|--------|
| 5064-0001 | S |
| 5064-0002 | M |
| 5064-0003 | L |

Pince en T pour fémur



| RÉF. NO |
|-----------|
| 5094-0001 |

Pince à 135° (activée)



| RÉF. NO |
|-----------|
| 5104-0001 |

Pince à 135° (activée)



| RÉF. NO |
|-----------|
| 5104-0002 |

Systemes de fixation externes

Fixateurs externes



Fixateur main-poignet Hybrit (Kit)



RÉF. NO

5134-0000

Fixateur main-poignet (kit)

RÉF. NO

5224-0000



Fixateur de compression main-poignet radiotransparent (kit)

RÉF. NO

5508-0000



Mini fixateur externe tubulaire (kit)

RÉF. NO

5884-0000



Mini fixateur externe Hybrit (kit)

RÉF. NO

5784-0000





Systèmes de fixation externes

Fixateurs externes



Humerus Hybrit
Fixateur externe (kit)

RÉF. NO

5294-0000

Fixateur hybride fémur-tibia

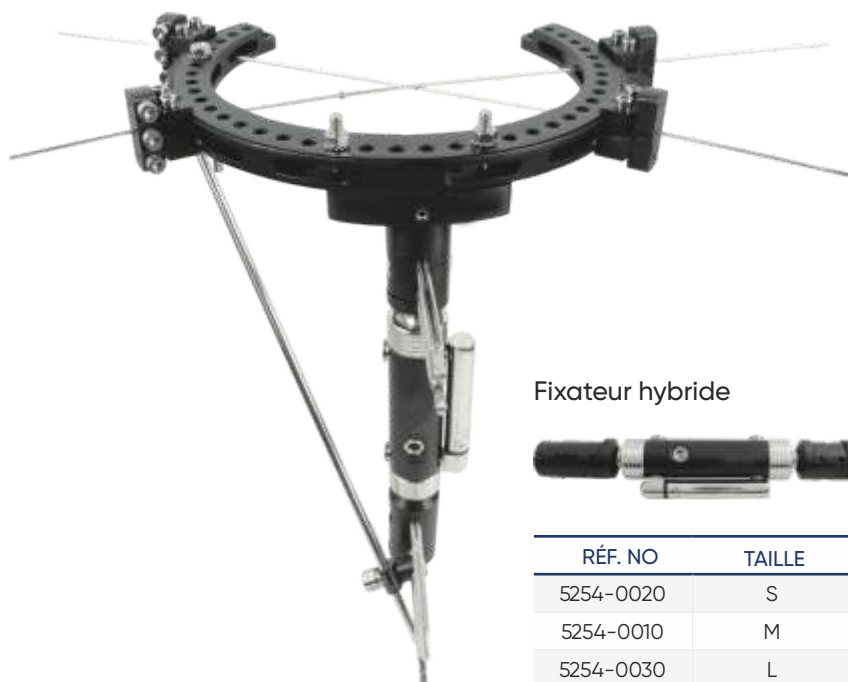

Fixateur hybride

| RÉF. NO | TAILLE |
|-----------|--------|
| 5254-0020 | S |
| 5254-0010 | M |
| 5254-0030 | L |

Pince de fixation hybride pour tige

RÉF. NO

5254-0012



Pince hybride

RÉF. NO

5254-0015



Pince à fil de fixation hybride

RÉF. NO

5254-0013



Tige de fixation hybride
Pièce de connexion



RÉF. NO

5254-0014

Tige de fixation hybride 6x400 mm



RÉF. NO

5255-0640

Fil Oliver Kirschner Ø2x440



RÉF. NO

6251-2044

Fil de Kirschner Ø 2x440



RÉF. NO

6041-2044

Anneau de fixation hybride



RÉF. NO

5254-0170

5254-0190



Systemes de fixation externes

Petit ensemble de fixateurs tubulaires externes

Collier de serrage tige-tige Ø 5 mm

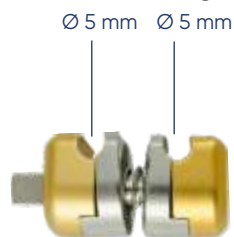

RÉF. NO
(AL)

5144-0020

Schanz - Serre-tige

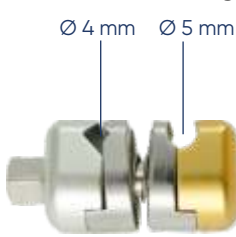

RÉF. NO
(AL)

5144-0023

Pince à broches multiplanaires



RÉF. NO
(AL)

5144-0001

Pince porte-broches planaire double



RÉF. NO
(AL)

5144-0005

Tige Ø 5 mm



| RÉF. NO (TI) | RÉF. NO (AL) | RÉF. NO (CR) | LONGUEUR (mm) |
|-----------------|-----------------|-----------------|------------------|
| 5142-0510 | 5144-0510 | 5148-0510 | 100 |
| 5142-0518 | 5144-0518 | 5148-0518 | 180 |
| 5142-0520 | 5144-0520 | 5148-0520 | 200 |
| 5142-0522 | 5144-0522 | 5148-0522 | 220 |
| 5142-0524 | 5144-0524 | 5148-0524 | 240 |
| 5142-0526 | 5144-0526 | 5148-0526 | 260 |
| 5142-0528 | 5144-0528 | 5148-0528 | 280 |
| 5142-0530 | 5144-0530 | 5148-0530 | 300 |
| 5142-0532 | 5144-0532 | 5148-0532 | 320 |
| 5142-0534 | 5144-0534 | 5148-0534 | 340 |
| 5142-0536 | 5144-0536 | 5148-0536 | 360 |
| 5142-0538 | 5144-0538 | 5148-0538 | 380 |
| 5142-0540 | 5144-0540 | 5148-0540 | 400 |

Pièce de connexion coudée 30°



RÉF. NO
(SS)

5141-0025

Pièce de connexion horizontale



RÉF. NO
(SS)

5141-0020

Anneau d'angle incliné

| RÉF. NO (AL) | SIZE |
|-----------------|------|
| 5144-0003 | S |
| 5144-0004 | L |



Systemes de fixation externes

Ensemble de grands fixateurs tubulaires externes



Collier de serrage tige-tige Ø 8 mm

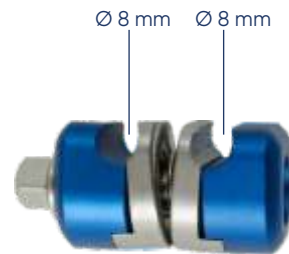

RÉF. N°
(AL)
5144-0021

Schanz - Serre-tige

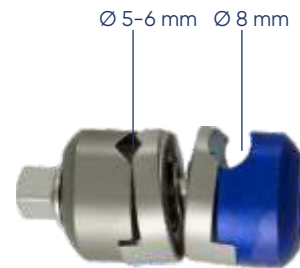

RÉF. N°
(AL)
5144-0024

Tige Ø 8 mm



| RÉF. N° (TI) | RÉF. N° (AL) | RÉF. N° (CR) | LONGUEUR (mm) |
|-----------------|-----------------|-----------------|------------------|
| 5142-0818 | 5144-0818 | 5148-0818 | 180 |
| 5142-0820 | 5144-0820 | 5148-0820 | 200 |
| 5142-0822 | 5144-0822 | 5148-0822 | 220 |
| 5142-0824 | 5144-0824 | 5148-0824 | 240 |
| 5142-0826 | 5144-0826 | 5148-0826 | 260 |
| 5142-0828 | 5144-0828 | 5148-0828 | 280 |
| 5142-0830 | 5144-0830 | 5148-0830 | 300 |
| 5142-0832 | 5144-0832 | 5148-0832 | 320 |
| 5142-0834 | 5144-0834 | 5148-0834 | 340 |
| 5142-0836 | 5144-0836 | 5148-0836 | 360 |
| 5142-0838 | 5144-0838 | 5148-0838 | 380 |
| 5142-0840 | 5144-0840 | 5148-0840 | 400 |

Pince porte-broches planaire double



RÉF. N°
(AL)
5144-0006

Pièce de connexion coudée 30°



REF. NO
(SS)
5141-0015

Anneau d'angle incliné



| RÉF. N° (AL) | LONGUEUR (mm) |
|-----------------|------------------|
| 5144-0140 | 140 |
| 5144-0156 | 156 |
| 5144-0192 | 192 |

Pièce de connexion horizontale



RÉF. N°
(SS)
5141-0010
5141-0015
5141-0020
5141-0025





Broches et fils squelettiques

Vis de Schanz (filetage cortical)



| RÉF. N° (SS) | LONGUEUR (mm) | DIAMÈTRE |
|-----------------|------------------|----------|
| 6011-2050 | 50 | Ø 2mm |
| 6011-2060 | 60 | Ø 2mm |
| 6011-2070 | 70 | Ø 2mm |
| 6011-2080 | 80 | Ø 2mm |
| 6011-2090 | 90 | Ø 2mm |
| 6011-2100 | 100 | Ø 2mm |
| 6011-3060 | 60 | Ø 3mm |
| 6011-3070 | 70 | Ø 3mm |
| 6011-3080 | 80 | Ø 3mm |
| 6011-3090 | 90 | Ø 3mm |
| 6011-3100 | 100 | Ø 3mm |
| 6011-3110 | 110 | Ø 3mm |
| 6011-3120 | 120 | Ø 3mm |
| 6011-4070 | 70 | Ø 4mm |
| 6011-4080 | 80 | Ø 4mm |
| 6011-4090 | 90 | Ø 4mm |
| 6011-4100 | 100 | Ø 4mm |
| 6011-4110 | 110 | Ø 4mm |
| 6011-4120 | 120 | Ø 4mm |
| 6011-4130 | 130 | Ø 4mm |
| 6011-4140 | 140 | Ø 4mm |

| RÉF. N° (SS) | LONGUEUR (mm) | DIAMÈTRE |
|-----------------|------------------|----------|
| 6011-5140 | 140 | Ø 5mm |
| 6011-5160 | 160 | Ø 5mm |
| 6011-5180 | 180 | Ø 5mm |
| 6011-5200 | 200 | Ø 5mm |
| 6011-5220 | 220 | Ø 5mm |
| 6011-5240 | 240 | Ø 5mm |
| 6011-5260 | 260 | Ø 5mm |
| 6011-6140 | 140 | Ø 6mm |
| 6011-6160 | 160 | Ø 6mm |
| 6011-6180 | 180 | Ø 6mm |
| 6011-6200 | 200 | Ø 6mm |
| 6011-6220 | 220 | Ø 6mm |
| 6011-6240 | 240 | Ø 6mm |
| 6011-6260 | 260 | Ø 6mm |

Pointe filetée pour fil de Kirschner



| RÉF. N° (SS) | LONGUEUR (mm) | DIAMÈTRE |
|-----------------|------------------|----------|
| 6091-0830 | 300 | Ø 0.8 mm |
| 6091-1030 | 300 | Ø 1.0 mm |
| 6091-1230 | 300 | Ø 1.2 mm |
| 6091-1530 | 300 | Ø 1.5 mm |
| 6091-1830 | 300 | Ø 1.8 mm |
| 6091-2030 | 300 | Ø 2.0 mm |
| 6091-2530 | 300 | Ø 2.5 mm |
| 6091-3030 | 300 | Ø 3.0 mm |
| 6091-3530 | 300 | Ø 3.5 mm |
| 6091-4030 | 300 | Ø 4.0 mm |

Pointe de trocart pour broche de Kirschner



| RÉF. N° (SS) | LONGUEUR (mm) | DIAMÈTRE |
|-----------------|------------------|----------|
| 6041-0830 | 300 | Ø 0.8 mm |
| 6041-1030 | 300 | Ø 1.0 mm |
| 6041-1230 | 300 | Ø 1.2 mm |
| 6041-1530 | 300 | Ø 1.5 mm |
| 6041-1830 | 300 | Ø 1.8 mm |
| 6041-2030 | 300 | Ø 2.0 mm |
| 6041-2530 | 300 | Ø 2.5 mm |
| 6041-3030 | 300 | Ø 3.0 mm |
| 6041-3530 | 300 | Ø 3.5 mm |

Épinglette Steinmann



| RÉF. N° (SS) | LONGUEUR (mm) | DIAMÈTRE |
|-----------------|------------------|----------|
| 6031-4030 | 300 | Ø 4.0 mm |
| 6031-4530 | 300 | Ø 4.5 mm |
| 6031-5030 | 300 | Ø 5.0 mm |
| 6031-6030 | 300 | Ø 6.0 mm |

Vis polyaxiales

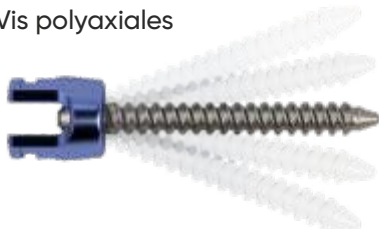

| RÉF. NON (TI) Ø 4.5 mm | RÉF. NON (TI) Ø 5.5 mm | RÉF. NON (TI) Ø 6.5 mm | RÉF. NON (TI) Ø 7.5 mm | TAILLE (mm) |
|---------------------------|---------------------------|---------------------------|---------------------------|----------------|
| 3012-4525 | - | - | - | 25 |
| 3012-4530 | 3012-5530 | 3012-6530 | 3012-7530 | 30 |
| 3012-4535 | 3012-5535 | 3012-6535 | 3012-7535 | 35 |
| 3012-4540 | 3012-5540 | 3012-6540 | 3012-7540 | 40 |
| 3012-4545 | 3012-5545 | 3012-6545 | 3012-7545 | 45 |
| - | 3012-5550 | 3012-6550 | 3012-7550 | 50 |
| - | 3012-5555 | 3012-6555 | 3012-7555 | 55 |
| - | 3012-5560 | 3012-6560 | 3012-7560 | 60 |

Vis monoaxiales



| RÉF. NON (TI) Ø 4.5 mm | RÉF. NON (TI) Ø 5.5 mm | RÉF. NON (TI) Ø 6.5 mm | RÉF. NON (TI) Ø 7.5 mm | TAILLE (mm) |
|---------------------------|---------------------------|---------------------------|---------------------------|----------------|
| 3022-4525 | - | - | - | 25 |
| 3022-4530 | 3022-5530 | - | - | 30 |
| 3022-4535 | 3022-5535 | 3022-6535 | - | 35 |
| 3022-4540 | 3022-5540 | 3022-6540 | - | 40 |
| - | 3022-5545 | 3022-6545 | - | 45 |
| - | 3022-5550 | 3022-6550 | - | 50 |
| - | 3022-5555 | 3022-6555 | - | 55 |

Tige vertébrale Ø 5,5 mm



| RÉF. NON (TI) | TAILLE (mm) |
|------------------|----------------|
| 3052-5505 | 50 |
| 3052-5507 | 70 |
| 3052-5509 | 90 |
| 3052-5510 | 100 |
| 3052-5511 | 110 |
| 3052-5513 | 130 |
| 3052-5515 | 150 |
| 3052-5517 | 170 |
| 3052-5518 | 180 |
| 3052-5520 | 200 |
| 3052-5522 | 220 |
| 3052-5524 | 240 |
| 3052-5526 | 260 |
| 3052-5540 | 400 |

Vis polyaxiales pour spondylolisthésis

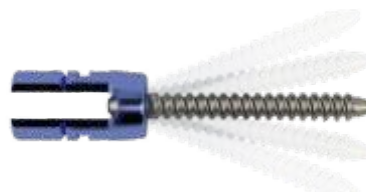

| RÉF. NON (TI) Ø 4.5 mm | RÉF. NON (TI) Ø 5.5 mm | RÉF. NON (TI) Ø 6.5 mm | RÉF. NON (TI) Ø 7.5 mm | TAILLE (mm) |
|---------------------------|---------------------------|---------------------------|---------------------------|----------------|
| 3032-4525 | - | - | - | 25 |
| 3032-4530 | 3032-5530 | 3032-6530 | 3032-7530 | 30 |
| 3032-4535 | 3032-5535 | 3032-6535 | 3032-7535 | 35 |
| 3032-4540 | 3032-5540 | 3032-6540 | 3032-7540 | 40 |
| 3032-4545 | 3032-5545 | 3032-6545 | 3032-7545 | 45 |
| - | 3032-5550 | 3032-6550 | 3032-7550 | 50 |
| - | 3032-5555 | 3032-6555 | 3032-7555 | 55 |
| - | 3032-5560 | 3032-6560 | 3032-7560 | 60 |

Connecteur transversal Crosslink



| RÉF. NON (TI) | TAILLE (mm) |
|------------------|----------------|
| 3062-0360 | 60 |
| 3062-0365 | 65 |
| 3062-0370 | 70 |
| 3062-0375 | 75 |
| 3062-0380 | 80 |

Connecteur transversal coudé



| RÉF. NON (TI) | TAILLE (mm) |
|------------------|----------------|
| 3082-0060 | 60 |
| 3082-0065 | 65 |
| 3082-0070 | 70 |
| 3082-0075 | 75 |
| 3082-0080 | 80 |

Crochet de connecteur transversal



| RÉF. NON (TI) |
|------------------|
| 3072-0001 |



U Agrafe
(TI)

| RÉF. NON | LONGUEUR (mm) |
|-----------|------------------|
| 6062-0006 | 6 |
| 6062-0008 | 8 |
| 6062-0010 | 10 |
| 6062-0012 | 12 |
| | |
| | |



Rev3 (25-04-24)

ISO 9001:2015
ISO 13485:2016



Ostéo France Ortho

3 RUE DU ROMPOT
21121 FONTAINE LES DIJON
TEL: 0184609200
FAX: 01 84 10 61 25
email: contact@osteofrance-ortho.fr
<http://www.osteofrance-ortho.fr>